

## Errata

**Title & Document Type: 436A Power Meter Operating and Service Manual**

**Manual Part Number: 00436-90053**

**Revision Date: 1988-03-01**

---

### HP References in this Manual

This manual may contain references to HP or Hewlett-Packard. Please note that Hewlett-Packard's former test and measurement, semiconductor products and chemical analysis businesses are now part of Agilent Technologies. We have made no changes to this manual copy. The HP XXXX referred to in this document is now the Agilent XXXX. For example, model number HP8648A is now model number Agilent 8648A.

### About this Manual

We've added this manual to the Agilent website in an effort to help you support your product. This manual provides the best information we could find. It may be incomplete or contain dated information, and the scan quality may not be ideal. If we find a better copy in the future, we will add it to the Agilent website.

### Support for Your Product

Agilent no longer sells or supports this product. You will find any other available product information on the Agilent Test & Measurement website:

[www.tm.agilent.com](http://www.tm.agilent.com)

Search for the model number of this product, and the resulting product page will guide you to any available information. Our service centers may be able to perform calibration if no repair parts are needed, but no other support from Agilent is available.

# OPERATING AND SERVICE MANUAL

## HP 436A POWER METER

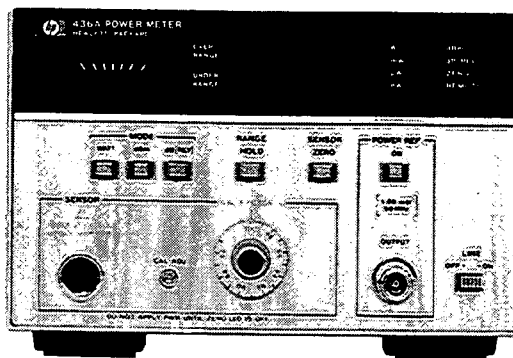

HP Part No. 00436-90053  
Edition 1 E0489  
HP Binder Part No. 9282-1078



## **CERTIFICATION**

*Hewlett-Packard Company certifies that this product met its published specifications at the time of shipment from the factory. Hewlett-Packard further certifies that its calibration measurements are traceable to the United States National Bureau of Standards, to the extent allowed by the Bureau's calibration facility, and to the calibration facilities of other International Standards Organization members.*

## **WARRANTY**

This Hewlett-Packard instrument product is warranted against defects in material and workmanship for a period of one year from date of shipment. During the warranty period, Hewlett-Packard Company will, at its option, either repair or replace products which prove to be defective.

For warranty service or repair, this product must be returned to a service facility designated by HP. Buyer shall prepay shipping charges to HP and HP shall pay shipping charges to return the product to Buyer. However, Buyer shall pay all shipping charges, duties, and taxes for products returned to HP from another country.

HP warrants that its software and firmware designated by HP for use with an instrument will execute its programming instructions when properly installed on that instrument. HP does not warrant that the operation of the instrument, or software, or firmware will be uninterrupted or error free.

### **LIMITATION OF WARRANTY**

The foregoing warranty shall not apply to defects resulting from improper or inadequate maintenance by Buyer, Buyer-supplied software or interfacing, unauthorized modification or misuse, operation outside of the environmental specifications for the product, or improper site preparation or maintenance.

**NO OTHER WARRANTY IS EXPRESSED OR IMPLIED. HP SPECIFICALLY DISCLAIMS THE IMPLIED WARRANTIES OF MERCHANTABILITY AND FITNESS FOR A PARTICULAR PURPOSE.**

### **EXCLUSIVE REMEDIES**

**THE REMEDIES PROVIDED HEREIN ARE BUYER'S SOLE AND EXCLUSIVE REMEDIES. HP SHALL NOT BE LIABLE FOR ANY DIRECT, INDIRECT, SPECIAL, INCIDENTAL, OR CONSEQUENTIAL DAMAGES, WHETHER BASED ON CONTRACT, TORT, OR ANY OTHER LEGAL THEORY.**

## **ASSISTANCE**

*Product maintenance agreements and other customer assistance agreements are available for Hewlett-Packard products.*

*For any assistance, contact your nearest Hewlett-Packard Sales and Service Office. Addresses are provided at the back of this manual.*

# HP 436A

## POWER METER

(Including Options 003, 004 and 022)

### SERIAL NUMBERS

This manual applies directly to instruments with serial numbers prefixed 2410A and 2410U.

With changes described in Section VII, this manual also applies to instruments with serial numbers prefixed:

1447A, 1448A, 1451A, 1501A, 1503A, 1504A, 1505A, 1538A, 1550A, 1606A, 1611A, 1629A, 1713A, 1725A, 1746A, 1803A, 1908A, 1911A, 1917A, 1918A, 1930A, 2008A, 2016A, 2101A, 2236A, 2330A, 2347A and 2347U.

For additional important information about serial numbers, see INSTRUMENTS COVERED BY MANUAL in Section I.



© Copyright HEWLETT-PACKARD COMPANY 1975, 1977, 1980, 1984, 1988  
1501 PAGE MILL ROAD, PALO ALTO, CALIFORNIA, U.S.A.

MANUAL PART NO. 00436-90053

Edition 1 E0489

HP Binder Part No. 9282-1078

Microfiche Part No. 00436-90054

## HP 436A

### Herstellerbescheinigung

Hiermit wird bescheinigt, dass dieses Gerät/System in Übereinstimmung mit den Bestimmungen von Postverfügung 1046/84 funkenstört ist.

Der Deutschen Bundespost wurde das Inverkehrbringen dieses Gerätes/Systems angezeigt und die Berechtigung zur Überprüfung der Serie auf Einhaltung der Bestimmungen eingeräumt.

Zusatzinformation für Mess- und Testgeräte:

Werden Mess- und Testgeräte mit ungeschirmten Kabeln und/oder in offenen Messaufbauten verwendet, so ist vom Betreiber sicherzustellen, dass die Funk-Entstörbestimmungen unter Betriebsbedingungen an seiner Grundstücksgrenze eingehalten werden.

### Manufacturer's Declaration

This is to certify that this product meets the radio frequency interference requirements of Directive FTZ 1046/1984. The German Bundespost has been notified that this equipment was put into circulation and has been granted the right to check the product type for compliance with these requirements.

Note: If test and measurement equipment is operated with unshielded cables and/or used for measurements on open set-ups, the user must ensure that under these operating conditions, the radio frequency interference limits are met at the border of his premises.

# CONTENTS

Section	Page	Section	Page
<b>I GENERAL INFORMATION</b> .....	1-1	3-52. Sending the Required Service Message ....	3-23
1-1. Introduction .....	1-1	3-54. Sending the Status Byte Message .....	3-23
1-6. Specifications .....	1-1	3-56. Sending the Status Bit Message .....	3-23
1-8. Instruments Covered by Manual .....	1-1	3-58. Receiving the Abort Message .....	3-23
1-14. Description .....	1-1	3-60. Test of HP-IB Operation .....	3-23
1-18. Options .....	1-3	3-62. Power Measurement Accuracy .....	3-23
1-19. Input-Output Options .....	1-3	3-64. Sources of Error and Measurement	
1-22. Remote Control Options .....	1-3	Uncertainty .....	3-30
1-25. Accessories Supplied .....	1-4	3-70. Corrections for Error .....	3-30
1-27. Equipment Required but not Supplied .....	1-4	3-75. Calculating Total Uncertainty .....	3-30
1-29. Equipment Available .....	1-4		
1-33. Recommended Test Equipment .....	1-4	<b>IV PERFORMANCE TESTS</b> .....	4-1
1-35. Safety Considerations .....	1-4	4-1. Introduction .....	4-1
<b>II INSTALLATION</b> .....	2-1	4-3. Equipment Required .....	4-1
2-1. Introduction .....	2-1	4-5. Test Record .....	4-1
2-3. Initial Inspection .....	2-1	4-7. Performance Tests .....	4-1
2-5. Preparation for Use .....	2-1	4-10. Zero Carryover Test .....	4-2
2-6. Power Requirements .....	2-1	4-11. Instrument Accuracy Test .....	4-3
2-8. Line Voltage and Fuse Selection .....	2-1	4-12. Calibration Factor Test .....	4-6
2-10. Power Cable .....	2-2	4-13. Power Reference Level Test .....	4-7
2-12. Address Selection .....	2-2		
2-13. Circuit Options .....	2-2	<b>V ADJUSTMENTS</b> .....	5-1
2-15. Interconnections .....	2-2	5-1. Introduction .....	5-1
2-18. Mating Connectors .....	2-3	5-4. Safety Considerations .....	5-1
2-21. Operating Environment .....	2-3	5-10. Equipment Required .....	5-1
2-23. Bench Operation .....	2-3	5-12. Factory Selected Components .....	5-1
2-25. Rack Mounting .....	2-3	5-14. Adjustment Locations .....	5-1
2-28. Storage and Shipment .....	2-3	5-16. DC Offset Adjustment .....	5-3
2-29. Environment .....	2-3	5-17. Auto Zero Offset Adjustment .....	5-3
2-31. Packaging .....	2-3	5-18. Spike Balance Adjustment .....	5-4
		5-19. Multivibrator Adjustment .....	5-6
<b>III OPERATION</b> .....	3-1	5-20. A-D Converter and Linear Meter	
3-1. Introduction .....	3-1	Adjustment .....	5-7
3-4. Panel Features .....	3-1	5-21. Power Reference Oscillator Frequency	
3-6. Operator's Maintenance .....	3-1	Adjustment .....	5-8
3-8. Operator's Checks .....	3-1	5-22. Power Reference Oscillator Level	
3-10. Local Operating Instructions .....	3-1	Adjustment .....	5-10
3-12. Hewlett-Packard Interface Bus Remote		5-23. Power Supply Adjustments .....	5-13
Operation .....	3-14		
3-14. Compatibility .....	3-14	<b>VI REPLACEABLE PARTS</b> .....	6-1
3-18. Data Messages .....	3-14	6-1. Introduction .....	6-1
3-21. Receiving Data Messages .....	3-14	6-3. Abbreviations .....	6-1
3-32. Sending Data Messages from the Power		6-5. Replaceable Parts List .....	6-1
Meter .....	3-18	6-7. Ordering Information .....	6-1
3-40. Receiving the Trigger Message .....	3-23	6-10. Parts Provisioning .....	6-1
3-42. Receiving the Clear Message .....	3-23	6-12. Direct Mail Order System .....	6-1
3-44. Receiving the Remote Message .....	3-23		
3-46. Receiving the Local Message .....	3-23	<b>VII MANUAL CHANGES</b> .....	7-1
3-48. Receiving the Local Lockout and		7-1. Introduction .....	7-1
Clear Lockout Set Local Messages .....	3-23	7-3. Manual Changes .....	7-1
3-50. Receiving the Pass Control Message .....	3-23	7-6. Manual Change Instructions .....	7-3



## CONTENTS (cont'd)

Section	Page	Section	Page
VIII SERVICE .....	8-1	8-30. Digital Integrated Circuits and Symbols ..	8-7
8-1. Introduction .....	8-1	8-55. Troubleshooting .....	8-16
8-3. Safety Considerations .....	8-1	8-59. Standard Instrument Checkout .....	8-16
8-9. Recommended Test Equipment .....	8-5	8-64. HP-IB Instrument Checkout .....	8-69
8-11. Service Aids .....	8-5	8-70. Block Diagram Circuit Descriptions .....	8-117
8-16. Repair .....	8-5	8-71. Service Sheet 1 .....	8-117
8-17. Factory Selected Components .....	8-5	8-75. Service Sheet 2 .....	8-118
8-19. Disassembly and Reassembly Procedures .....	8-5	8-87. Service Sheet 3 .....	8-122
8-24. Basic Circuit Descriptions .....	8-7	8-114. Service Sheet 4 .....	8-144
8-25. Linear Integrated Circuits .....	8-7	8-117. Command Mode Operation .....	8-144
		8-130. Data Mode Operation .....	8-147

## ILLUSTRATIONS

Figure	Page	Figure	Page
1-1. HP Model 436A Power Meter and Accessories Supplied .....	1-0	5-6. Power Reference Oscillator Frequency Adjustment Setup .....	5-8
2-1. Line Voltage and Fuse Selection .....	2-1	5-7. Power Reference Oscillator Level Adjustment Setup .....	5-10
2-2. Power Cable and Mains Plug Part Numbers .....	2-2		
2-3. Hewlett-Packard Interface Bus Connection ...	2-5	6-1. Cabinet Parts .....	6-19
3-1. Front and Rear Panel Controls, Connectors and Indicators .....	3-2	8-1. Schematic Diagram Notes .....	8-2
3-2. Operator's Checks .....	3-6	8-2. Front Panel Removal .....	8-6
3-3. Operating Instructions .....	3-11	8-3. Operational Amplifier Functional Circuits ...	8-8
3-4. Power Meter Response Curve (Settling Time for Analog Circuits) .....	3-20	8-4. Dual D-Type Flip-Flop .....	8-9
3-5. Measurement Timing Flow Chart (Settling Time for Digital Circuitry) .....	3-21	8-5. Four-Bit Bistable Latch .....	8-9
3-6. Operating Program Simplified Flow Chart .....	3-22	8-6. Dual J-K Master/Slave Flip-Flop and Gate Pulse Timing .....	8-10
3-7. Test of HP-IB Operation Flowchart .....	3-24	8-7. Dual J-K Edge-Triggered Flip-Flop .....	8-10
3-8. 436A Quick Programming Guide .....	3-25	8-8. Programmable Counters .....	8-11
3-9. Calculating Measurement Uncertainties ...	3-32	8-9. 3-Line to 8-Line Decoder .....	8-12
3-10. The Effect of Power Sensor Mismatch on Measurement Accuracy .....	3-34	8-10. 8-Input Data Selector (Multiplexer) .....	8-13
3-11. Calculating Measurement Uncertainty (Uncertainty in dB Known) .....	3-35	8-11. LED Display Driver .....	8-14
4-1. Zero Carryover Test Setup .....	4-2	8-12. Numeric Display .....	8-15
4-2. Instrument Accuracy Test Setup .....	4-4	8-13. MOS and TTL ROMs .....	8-15
4-3. Calibration Factor Test Setup .....	4-6	8-14. Power Meter Operating Cycle .....	8-17
4-4. Power Reference Level Test Setup .....	4-8	8-15. Operating Program Flow Chart .....	8-25
5-1. DC Offset Adjustment Setup .....	5-3	8-16. HP-IB Verification Program (HP 9830A Calculator) .....	8-70
5-2. Auto Zero Offset Adjustment Setup .....	5-4	8-17. HP-IB Verification Program (HP 9820A Calculator) .....	8-95
5-3. Spike Balance Adjustment Setup .....	5-5	8-18. Analog-to-Digital Converter Simplified Diagram and Waveforms .....	8-120
5-4. Multivibrator Adjustment Setup .....	5-6	8-19. HP-IB Listen Handshake Timing .....	8-145
5-5. A-D Converter and Linear Meter Adjustment Setup .....	5-7	8-20. Data Valid Status Generator Timing .....	8-154
		8-21. Overall Block Diagram .....	8-159
		8-22. AC Gain, A-D Converter and Display Circuits Block Diagram .....	8-161
		8-23. Controller and Counters Block Diagram ...	8-163
		8-24. HP-IB (Opt. 022) Circuit Block Diagram ...	8-165

### ILLUSTRATIONS (cont'd)

Figure	Page	Figure	Page
8-26. A1A1 Display Assembly Component Locations .....	8-169	8-38. A6 HP-IB (Option 022) Control Assembly Component and Test Point Locations ...	8-178
8-27. A1A2 Pushbutton Assembly Component Locations .....	8-169	8-39. HP-IB (Option 022) Control Assembly Schematic Diagram .....	8-179
8-28. Front Panel Assembly Schematic Diagram .....	8-169	8-40. A7 HP-IB (Option 022) Input/Output Assembly Component and Test Point Locations .....	8-181
8-29. A2 AC Gain Assembly Component, Test Point, and Adjustment Locations .....	8-171	8-41. HP-IB (Option 022) Input/Output Assembly Schematic Diagram .....	8-181
8-30. AC Gain Assembly Schematic Diagram ...	8-171	8-44. A8 Power Reference Oscillator Assembly Component, Test Point, and Adjustment Locations .....	8-187
8-31. A1A3 CAL FACTOR % Switch Assembly Component Locations .....	8-173	8-45. Power Reference Oscillator Assembly Schematic Diagram .....	8-187
8-32. A3 A-D Converter Assembly Components, Test Point, and Adjustment Locations .....	8-173	8-46. A9 Power Supply Rectifier and Regulator Assembly Component and Test Point Locations .....	8-189
8-33. A-D Converter Assembly Schematic Diagram .....	8-173	8-47. Rear Panel Mounted Power Supply Component Locations .....	8-189
8-34. A4 Counter Relative Assembly Component and Test Point Locations ...	8-175	8-48. Power Supply Rectifier and Regulator Assembly Schematic Diagram .....	8-189
8-35. Counter Relative Assembly Schematic Diagram .....	8-175	8-49. Rear View of Front Panel (Removed).....	8-191
8-36. A5 Controller Assembly Component and Test Point Locations .....	8-177	8-50. Top Internal View Standard Instrument ...	8-191
8-37. Controller Assembly Schematic Diagram .....	8-177	8-51. Top Internal View HP-IB .....	8-191

### TABLES

Table	Page	Table	Page
1-1. Specifications .....	1-2	4-5. Performance Test Record .....	4-10
1-2. Recommended Test Equipment .....	1-5	5-1. Factory Selected Components .....	5-2
2-1. Line Fuse Ratings and Part Numbers .....	2-2	6-1. Reference Designators and Abbreviations ...	6-2
2-2. Circuit Options .....	2-4	6-2. Replaceable Parts .....	6-4
2-3. USA Standard Code for Information Interchange (ASCII) .....	2-4	6-3. Code List of Manufacturers .....	6-21
3-1. Message Reference Table .....	3-15	7-1. Manual Changes by Serial Number .....	7-1
3-2. Measurement Sequence .....	3-16	7-2. Summary of Manual Changes by Page Number .....	7-2
3-3. Hewlett-Packard Interface Bus Input Program Codes .....	3-17	8-1. Logic Levels and Power Requirements .....	8-9
3-4. Hewlett-Packard Interface Bus Output Data String .....	3-19	8-2. Program Mnemonic Descriptions .....	8-20
3-5. Power Meter Remote Access Time to First Output Data Character .....	3-20	8-3. Standard Instrument Checkout .....	8-52
4-1. Zero Carryover Autorange Digital Readout Results .....	4-3	8-4. HP-IB Circuit Troubleshooting .....	8-99
4-2. Instrument Accuracy Test Results .....	4-5	8-6. Operating Program Description .....	8-124
4-3. Instrument Accuracy Test Results for dB [REF] Mode .....	4-5	8-7. Up/Down Count Control Logic Steering ...	8-139
4-4. Calibration Factor Test Results .....	4-7	8-8. Function Decoder Clock Selection .....	8-149
		8-9. Programming Command Logic Operating Summary .....	8-149
		8-10. Power Meter Talk HP-IB Output Data Format .....	8-155



## SERVICE SHEETS

Service Sheet	Page	Service Sheet	Page
<b>1</b> Overall Block Diagram .....	8-159	<b>8</b> A-D Converter Assembly (A1A3, A3) .....	8-173
<b>2</b> AC Gain, A-D Converter, and Display Circuits Block Diagram (A1A1, A2, A3) ...	8-161	<b>9</b> Counter Relative Assembly (A4) .....	8-175
<b>3</b> Controller and Counters Block Diagram (A1A2, A4, A5) .....	8-163	<b>10</b> Controller Assembly (A5) .....	8-177
<b>4</b> HP-IB (Option 022) Circuit Block Diagram (A6, A7) .....	8-165	<b>11</b> HP-IB (Option 022) Control Assembly (A6) ...	8-179
<b>6</b> Front Panel Assembly (A1A1, A1A2) .....	8-169	<b>12</b> HP-IB (Option 022) Input/Output Assembly (A7) .....	8-181
<b>7</b> AC Gain Assembly (A2) .....	8-171	<b>14</b> Power Reference Oscillator Assembly (A8) ...	8-187
		<b>15</b> Power Supply Rectifier and Regulator Assembly (A9, A10) .....	8-189

## SAFETY CONSIDERATIONS

### GENERAL

This product and related documentation must be reviewed for familiarization with safety markings and instructions before operation.

This product is a Safety Class I instrument (provided with a protective earth terminal).

### BEFORE APPLYING POWER

Verify that the product is set to match the available line voltage and the correct fuse is installed.

### SAFETY EARTH GROUND

An uninterruptible safety earth ground must be provided from the main power source to the product input wiring terminals, power cord, or supplied power cord set.

### WARNINGS

Any interruption of the protective (grounding) conductor (inside or outside the instrument) or disconnecting the protective earth terminal will cause a potential shock hazard that could result in personal injury. (Grounding one conductor of a two conductor outlet is not sufficient protection.) In addition, verify that a common ground exists between the unit under test and this instrument prior to energizing either unit.

Whenever it is likely that the protection has been impaired, the instrument must be made inoperative and be secured against any unintended operation.

If this instrument is to be energized via an auto-transformer (for voltage reduction) make sure the common terminal is connected to neutral (that is, the grounded side of the mains supply).

Servicing instructions are for use by service-trained personnel only. To avoid dangerous electric shock, do not perform any servicing unless qualified to do so.

Adjustments described in the manual are performed with power supplied to the instrument

while protective covers are removed. Energy available at many points may, if contacted, result in personal injury.

Capacitors inside the instrument may still be charged even if the instrument has been disconnected from its source of supply.

For continued protection against fire hazard, replace the line fuse(s) only with 250V fuse(s) of the same current rating and type (for example, normal blow, time delay, etc.). Do not use repaired fuses or short circuited fuseholders.

### SAFETY SYMBOLS



Instruction manual symbol: the product will be marked with this symbol when it is necessary for the user to refer to the instruction manual (see Table of Contents for page references).



Indicates hazardous voltages.



Indicates earth (ground) terminal.

### WARNING

The WARNING sign denotes a hazard. It calls attention to a procedure, practice, or the like, which, if not correctly performed or adhered to, could result in personal injury. Do not proceed beyond a WARNING sign until the indicated conditions are fully understood and met.

### CAUTION

The CAUTION sign denotes a hazard. It calls attention to an operating procedure, practice, or the like, which, if not correctly performed or adhered to, could result in damage to or destruction of part or all of the product. Do not proceed beyond a CAUTION sign until the indicated conditions are fully understood and met.



POWER METER

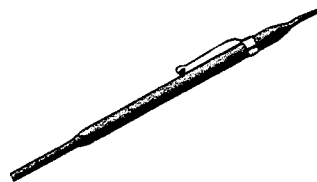

TUNING TOOL

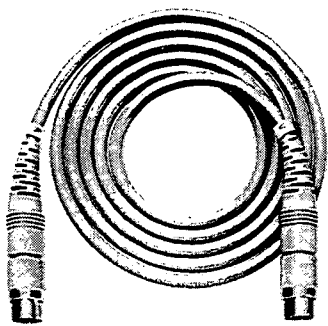

POWER SENSOR CABLE

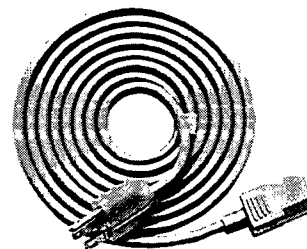

POWER CABLE

Figure 1-1. HP Model 436A Power Meter and Accessories Supplied

## SECTION I

### GENERAL INFORMATION

#### 1-1. INTRODUCTION

1-2. This manual provides information pertaining to the installation, operation, testing, adjustment and maintenance of the HP Model 436A Power Meter.

1-3. Figure 1-1 shows the Power Meter with accessories supplied.

1-4. Packaged with this manual is an Operating Information Supplement. This is simply a copy of the first three sections of this manual. This supplement should be kept with the instrument for use by the operator. Additional copies of the Operating Information Supplement may be ordered through your nearest Hewlett-Packard office. The part numbers are listed on the title page of this manual.

1-5. On the title page of this manual, below the manual part number, is a "Microfiche" part number. This number may be used to order 4x6-inch microfilm transparencies of the manual. The microfiche package also includes the latest Manual Changes supplement as well as all pertinent Service Notes.

#### 1-6. SPECIFICATIONS

1-7. Instrument specifications are listed in Table 1-1. These specifications are the performance standards or limits against which the instrument may be tested.

#### 1-8. INSTRUMENTS COVERED BY MANUAL

1-9. Power Meter Options 003, 004, and 022 are documented in this manual. The differences are noted in the appropriate location such as OPTIONS in Section I, the Replaceable Parts List, and the schematic diagrams.

1-10. This instrument has a two-part serial number. The first four digits and the letter comprise the serial number prefix. The last five digits form the sequential suffix that is unique to each instrument. The contents of this manual apply directly to instruments having the same serial

number prefix(es) as listed under SERIAL NUMBERS on the title page.

1-11. An instrument manufactured after the printing of this manual may have a serial prefix that is not listed on the title page. This unlisted serial prefix indicates that the instrument is different from those documented in this manual. The manual for this instrument is supplied with a yellow Manual Changes supplement that contains change information that documents the differences.

1-12. In addition to change information, the supplement may contain information for correcting errors in the manual. To keep this manual as current and accurate as possible, Hewlett-Packard recommends that you periodically request the latest Manual Changes supplement. The supplement for this manual is keyed to the manual's print date and part number, both of which appear on the title page. Complimentary copies of the supplement are available from Hewlett-Packard.

1-13. For information concerning a serial number prefix not listed on the title page or in the Manual Changes supplement, contact your nearest Hewlett-Packard office.

#### 1-14. DESCRIPTION

1-15. The Power Meter is a precision digital-readout instrument capable of automatic and manual measurement of RF and Microwave power levels. It is designed for interconnection with a compatible Power Sensor (refer to Table 1-1, Specifications) to form a complete power measurement system. The frequency and power range of the system are determined by the particular Power Sensor selected for use. With the Power Sensors available, the overall frequency range of the system is 100 kHz to 18 GHz, and the overall power range is -70 to +35 dBm.

1-16. Significant operating features of the Power Meter are as follows:

- **Digital Display:** The display is a four-digit, seven-segment LED, plus a sign when in the dBm or dB (REL) mode. It also has under- and

Table 1-1. Specifications

## SPECIFICATIONS

**Frequency Range:**

100 kHz to 26.5 GHz (depending on power sensor used).

**Power Range:**

(display calibrated in watts, dBm, and dB relative to reference power level).

With 8481A, 8482A, or 8483A sensors: 50 dB with 5 full scale ranges of -20, -10, 0, 10, and 20 dBm (10  $\mu$ W to 100 mW).

With 8481B or 8482B sensors: HP 8481B is 44 dB (1 mW to 25W) at 0 to 35°C and HP 8482B is 43 dB (1 mW to 20W) at 35°C to 55°C with 5 ranges of 10, 20, 30, 40 and 43 or 44 dBm.

With 8481H or 8482H sensors: 45 dB with 5 ranges of 0, 10, 20, 30 and 35 dBm (1 mW to 3W).

With 8484A sensor: 50 dB with 5 full scale ranges of -60, -50, -40, -30, and -20 dBm (1 nW to 10  $\mu$ W).

**Accuracy:****Instrumentation<sup>1</sup>:**

Watt mode:  $\pm 0.5\%$ .

dBm mode:  $\pm 0.02$  dB  $\pm 0.001$  dB/°C.<sup>3</sup>

dB [REL] mode<sup>2</sup>:  $\pm 0.02$  dB  $\pm 0.001$  dB/°C<sup>3</sup>

**Zero:** Automatic, operated by front panel switch.

**Zero set:**  $\pm 0.5\%$  of full scale on most sensitive range. typical,  $\pm 1$  count on other ranges.

**Zero carry over:**  $\pm 0.2\%$  of full scale when zeroed on the most sensitive range.

**Noise** (typical, at constant temperature, peak change over any one-minute interval): 20 pW (8484A); 40 nW (8481A, 8482A, 8483A); 4  $\mu$ W (8481H, 8482H).

**Drift** (1 hour, typical, at constant temperature after 24-hour warm-up): 20 pW (8484A); 10 nW (8481A, 8482A, 8483A); 1.0  $\mu$ W (8481H, 8482H).

**Power Reference:** Internal 50 MHz oscillator with Type N Female connector on front panel (or rear panel, Option 003 only).

Power output: 1.00 mW.

Factory set to  $\pm 0.7\%$ , traceable to the National Bureau of Standards.

Accuracy:  $\pm 1.2\%$  worst case ( $\pm 0.9\%$  rss) for one year (0°C to 55°C).

**Response Time:**

(0 to 99% of reading, five time constants)

Range 1 (most sensitive) <10 seconds.

Range 2 <1 second

Range 3-5 <100 milliseconds.

(Typical, measured at recorder output).

**Cal Factor:**

16-position switch normalizes meter reading to account for calibration factor or effective efficiency. Range 85% to 100% in 1% steps.

**Cal Adjustment:**

Front panel adjustment provides capability to adjust gain of meter to match power sensor in use.

**Recorder Output:**

Proportional to indicated power with 1 volt corresponding to full scale and 0.316 volts to -5 dB; 1 k $\Omega$  output impedance, BNC connector.

**RF Blanking Output:**

Open collector TTL; low corresponds to blanking when auto-zero mode is engaged.

**Display:**

Digital display with four digits, 20% over-range capability on all ranges. Also, uncalibrated analog peaking meter to see fast changes.

**Power Consumption:**

100V  $\pm 10\%$ , 48 to 66 Hz and 360 to 440 Hz.

120V +5%, -10%, 48 to 66 Hz and 360 to 440 Hz.

220 or 240V +5%, -10% 48 to 66 Hz.

Typically less than 24 watts (<25 watts for Opt. 022), 60 V·A maximum.

**Dimensions:**

134 mm High (5-1/4 inches).

213 mm Wide (8-3/8 inches).

279 mm Deep (11 inches).

**Net Weight:** 4.5 kg (10 lbs).

<sup>1</sup>Includes sensor non-linearity. Add +2, -4% on top range when using the 8481A, 8482A, or 8483A power sensors.

<sup>2</sup>Specifications are for within range measurements. For range-to-range accuracy add the range uncertainties.

<sup>3</sup>Referenced to 25°C.

**DESCRIPTION (cont'd)**

overrange indicators. There is a 20 percent overrange capability in all ranges. Large 10 mm (0.375 inch) digits are easy to see even in a high glare environment.

- **Auxiliary Meter:** Complements the digital display by showing fast changes in power level. Ideal for "peaking" transmitter output or other variable power devices.
- **Choice of Display in Watts, dBm or dB:** Absolute power can be read out in watts or dBm. Relative power measurements are made possible with the dB [REF] switch. Pressing this switch zeros the display for any applied input power and any deviation from this reference is shown in dB with a resolution of  $\pm 0.01$  dB. This capability is particularly useful in frequency response testing.
- **Power Units and Mode Annunciator:** The units annunciator provides error-free display interpretation by indicating appropriate power units in the watt mode. The mode annunciator indicates the mode of operation: dBm, dB (REL), ZERO or REMOTE.
- **Completely Autoranging:** The Power Meter automatically switches through its 5 ranges to provide completely "hands off" operation. The RANGE HOLD switch locks the Power Meter in one of its ranges when autoranging is not desired.
- **Automatic Sensor Recognition:** The Power Meter continually decodes the sensitivity of the Power Sensor to which it is connected. This information is then used to automatically control the digital display decimal point location and, when WATT MODE operation is selected, to light the appropriate power units annunciator.
- **Auto Zero:** Zeroing the meter is accomplished by merely depressing the SENSOR ZERO switch and waiting until the display shows all zeros before releasing it. The meter is ready to make measurements as soon as the zero light in the mode annunciator goes off.
- **RF Blanking Output:** Open collector TTL; low corresponds to blanking when the sensor zero is engaged. May be used to remove the RF input signal connected to the power sensor.
- **Calibration Accuracy:** A 1.00 mW, 50 MHz reference output is available at the front panel

for calibrating the Power Meter and the Power Sensor as a system. Calibration is accomplished using the CAL ADJ and CAL FACTOR % controls. The CAL ADJ control compensates for slight differences in sensitivity associated with a particular type of Power Sensor and the CAL FACTOR % control compensates for mismatch losses and effective efficiency over the frequency range of the Power Sensor.

- **Recorder Output:** Provides a linear output with respect to the input power level. For each range, a +1.00 Vdc output corresponds to a full scale input power level. Refer to Table 1-1, Specifications, for the full-scale range values associated with the various types of Power Sensors available.

1-17. The Hewlett-Packard Interface Bus (HP-IB) Option 022 allows full remote control operation of all the power meter functions (CAL FACTOR can be programmed to either 100% or the CAL FACTOR which has been manually set on the front panel). This option may be added by the user at a later time as his requirements grow.

**1-18. OPTIONS****1-19. Input-Output Options**

1-20. Option 003. A rear panel POWER REF OUTPUT connector replaces the standard front panel connector.

1-21. Option 004. The 1.5 metre (5 ft.) power sensor cable is not shipped with the power meter.

**1-22. Remote Control Options**

1-23. Option 022 adds remote interface capability to the Power Meter. Option 022 is compatible with the Hewlett-Packard Interface Bus (AH1, C0, DC2, DT1, L2, LEO, PP0, RL2, SH1, SR0, T3, TEO).

1-24. Option 022 may be ordered in kit form under HP part number 00436-60035. The kit contains a control assembly printed-circuit board, an input/output assembly printed circuit board, and a data cable for interconnection.

**1-25. ACCESSORIES SUPPLIED**

1-26. The accessories supplied with the Power Meter are shown in Figure 1-1.

a. The 1.5 metre (5 ft.) Power Sensor Cable, HP 11730A, is used to couple the Power Sensor to the Power Meter. Order option 004 to delete the standard 1.5 metre cable.

b. The line power cable may be supplied in one of four configurations. Refer to the paragraph entitled Power Cables in Section II.

c. An alignment tool for adjusting the CAL ADJ front panel control (HP Part No. 8710-0630).

**1-27. EQUIPMENT REQUIRED BUT NOT SUPPLIED**

1-28. To form a complete RF power measurement system, a Power Sensor such as the HP Model 8481A must be connected to the Power Meter via the Power Sensor cable.

**1-29. EQUIPMENT AVAILABLE**

1-30. The HP Model 11683A Range Calibrator is recommended for performance testing, adjusting, and troubleshooting the Power Meter. The Power Meter's range-to-range accuracy and auto-zero operation can easily be verified with the Calibrator. It also has the capability of supplying a full-scale test signal for each range.

1-31. Two extender boards (HP Part Numbers 5060-0258, and 5060-0630; 24 and 44 pins respectively) enable the Power Meter printed circuit assemblies to be accessed for service.

Rubber bumpers (HP Part No. 0403-0015) should be installed on the extender boards to prevent the boards from touching.

1-32. The following table lists the cable accessories and their lengths that are available for use with the Power Meter. Order option 004 if the standard 1.5 metre cable is not desired with a cable accessory.

Cable Accessory	Cable Length
HP 11730B	3.0 m (10 ft)
HP 11730C	6.1 m (20 ft)
HP 11730D	15.2 m (50 ft)
HP 11730E	30.5 m (100 ft)
HP 11730F	61.0 m (200 ft)

**1-33 RECOMMENDED TEST EQUIPMENT**

1-34. The test equipment shown in Table 1-2 is recommended for use during performance testing, adjustments, and troubleshooting. To ensure optimum performance of the Power Meter, the specifications of a substitute instrument must equal or exceed the critical specifications shown in the table.

**1-35 SAFETY CONSIDERATIONS**

1-36. The Power Meter is a Safety Class I instrument. This instrument has been designed according to international safety standards.

1-37. This operating and service manual contains information, cautions, and warnings which must be followed by the user to ensure safe operation and to retain the instrument in safe condition.

Table 1-2. Recommended Test Equipment

Instrument Type	Critical Specifications	Suggested Model	Use *
Range Calibrator	Chopped dc output for each range referenced to 1 mW range	HP 11683A	P,A,T
Digital Voltmeter	Function: DC, resistance Range Resistance: 200 ohms Vdc: 100 mVdc, 1000 mVdc, 10 Vdc, 100 Vdc 10M $\Omega$ input impedance 6-digit resolution ( $\pm 0.05\%$ of reading, $\pm 0.02\%$ of range)	HP 3456A	P,A,T
Power Meter	Range: 1 mW Transfer Accuracy (input -to-output): 0.2%	HP 432A	P, A
Thermistor Mount	SWR: 1.05, 50 MHz Accuracy: $\pm 0.5\%$ at 50 MHz	HP 478A-H75** or HP 478A-H76**	P, A
Counter	Frequency Range: 220 Hz, 50 MHz Sensitivity: 100 mVrms Accuracy: 0.01%	HP 5315A	A
Oscilloscope	Bandwidth: dc to 50 MHz Vertical Sensitivity: 0.2V/division Horizontal Sensitivity: 1 ms/division	HP 180C/ 1801A/1821A	T
Logic Analyzer	Clock Input: 60 kHz Trigger Word: 8 Bits Bit Input: TTL Display Word: 8 Bits	HP 1600A	T
<p>*P = Performance Tests; A = Adjustments; T = Troubleshooting</p> <p>**For maximum accuracy the 478A-H75 should be calibrated by the National Bureau of Standards. The 478A-H76, which includes HP Standards Laboratory calibration, may be used with a measurement system accuracy of 0.58% instead of 0.5%.</p>			



## SECTION II INSTALLATION

### 2-1. INTRODUCTION

2-2. This section provides all information necessary to install the Power Meter. Covered in the section are initial inspection, power requirements, line voltage selection, interconnection, circuit options, mounting, storage, and repackaging for shipment.

### 2-3. INITIAL INSPECTION

2-4. Inspect the shipping container for damage. If the shipping container or cushioning material is damaged, it should be kept until the contents of the shipment have been checked for completeness and the instrument has been checked mechanically and electrically. The contents of the shipment should be as shown in Figure 1-1. Procedures for checking electrical performance are given in Section IV. If the contents are incomplete, if there is mechanical damage or defect, or if the instrument does not pass the electrical performance test, notify the nearest Hewlett-Packard office. If the shipping container is damaged, or the cushioning material shows signs of stress, notify the carrier as well as the Hewlett-Packard office. Keep the shipping materials for the carrier's inspection.

### 2-5. PREPARATION FOR USE

#### 2-6. Power Requirements

2-7. The Power Meter requires a power source of 100, 120, 220, or 240 Vac, +5%, -10%, 48 to 440 Hz single phase. Power consumption is approximately 20 watts.

#### WARNING

*If this instrument is to be energized via an autotransformer for voltage reduction, make sure the common terminal is connected to the earthed pole of the power source.*

#### 2-8. Line Voltage and Fuse Selection

#### CAUTION

**BEFORE PLUGGING THIS INSTRUMENT into the Mains (line) voltage, be sure the correct voltage and fuse have been selected.**

2-9. A rear panel, line power module permits operation from 100, 120, 220, or 240 Vac. The number visible in the window (located on the module) indicates the nominal line voltage to which the instrument must be connected. Verify that the line voltage selection card and the fuse are matched to the power source. Refer to Figure 2-1, Line Voltage and Fuse Selection. Table 2-1 lists the ratings and HP part numbers for the replaceable fuses.

#### WARNING

*For protection against fire hazard, the line fuse for 220/240V operation should only be a 250V slow blow fuse with the correct current rating.*

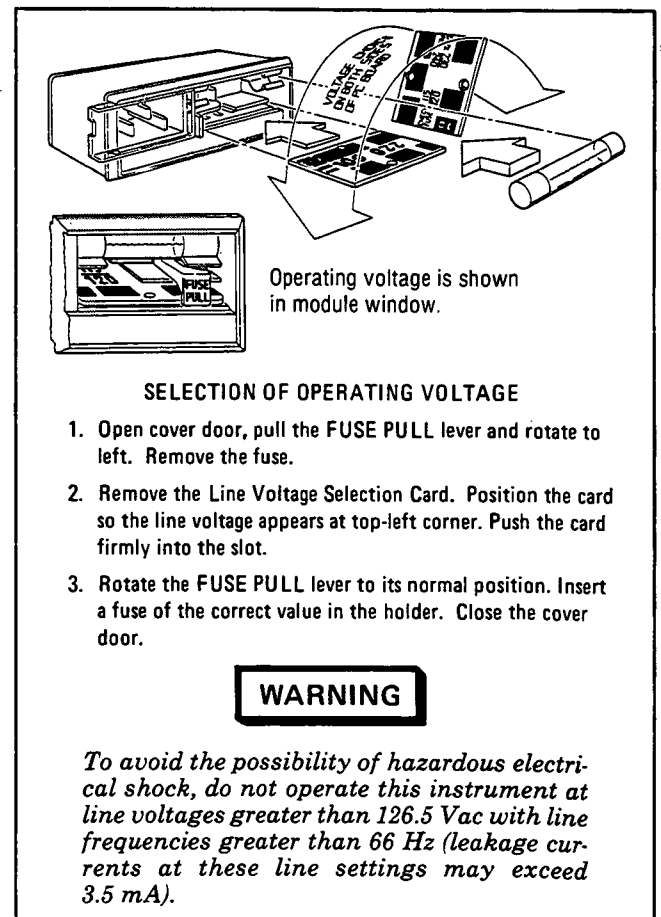

Figure 2-1. Line Voltage and Fuse Selection

Table 2-1. Line Fuse Ratings and Part Numbers

Line Voltage	Rating	Part Number
100/120V	.75A, 250V	2110-0063
220/240V	.375A, 250V, SLO-BLO	2110-0421

2-10. Power Cable

**WARNINGS**

*BEFORE SWITCHING ON THIS INSTRUMENT, the protective earth terminals of this instrument must be connected to the protective conductor of the (mains) power cord. The mains plug shall only be inserted in a socket outlet provided with a protective earth contact. The protective action must not be negated by the use of an extension cord (power cable) without a protective conductor (grounding).*

2-11. In accordance with international safety standards, this instrument is equipped with a three-wire power cable. When connected to an appropriate ac power receptacle, this cable grounds the instrument cabinet. The type of power cable plug shipped with each instrument depends on the country of destination. Refer to Figure 2-2 for the part numbers of the power cable plugs available.

2-12. ADDRESS SELECTION

**WARNINGS**

*This task should be performed only by service trained persons who are aware of the potential shock hazard of working on an instrument with protective covers removed.*

*To avoid hazardous electrical shock, the line (mains) power cable should be disconnected before attempting to change the HP-IB address.*

Look up the address code in Table 2-3. Read the binary equivalent of the code. Set the five least significant bits of the code on the address switch as shown below. (The address switch A6S1, is on the HP-IB Control Assembly.)

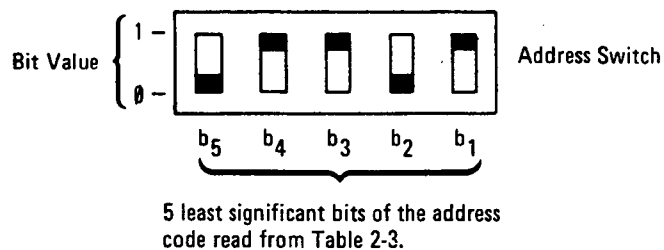

The switch is shown set for Talk address "M" (1001101) and Listen address "—" (0101101).

2-13. Circuit Options

2-14. A jumper option is available for selecting a filtered or unfiltered dc RECORDER OUTPUT. Table 2-2 lists the factory installed jumper connections and indicates how they may be reconnected to select the option.

2-15. Interconnections

2-16. Power Sensor. For proper system operation, the Power Sensor must be connected to the Power Meter using either the Power Sensor cable supplied with the Power Meter or any of the optional Power Sensor cables specified in Section I. Each of these cables employs a sensitivity line to enable the Power Meter to determine the operating range of the Power Sensor and thus, the true value of the input signal. For example, the 8481A and

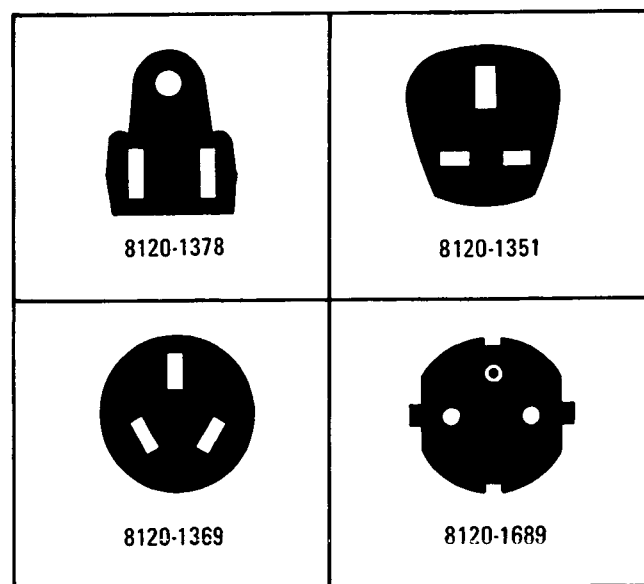

Figure 2-2. Power Cable and Mains Plug Part Numbers

8481H Power Sensors provide identical full scale outputs in response to input signal levels of 100 milliwatts and 3 watts, respectively. The difference in their sensitivity codes is detected by the Power Meter, however, and the Power Meter digital readout is automatically configured to indicate the appropriate value.

**2-17. Hewlett-Packard Interface Bus Option 022.** Interconnection data for Hewlett-Packard Interface Bus Option 022 is provided in Figure 2-3. Power Meter programming and output data format is described in Section III, Operation. HP-IB address selection is explained in Table 2-3.

**2-18. Mating Connectors**

**2-19. Interface Connector.** The interface mating connector for Option 022 is indicated in Figure 2-3.

**2-20. Coaxial Connectors.** Coaxial mating connectors used with the Power Meter should be US MIL-C-39012-compatible type N male or 50-ohm BNC male.

**2-21. Operating Environment**

2-22. The operating environment should be within the following limitations:

Temperature . . . . . 0°C to +55°C  
 Humidity . . . . . <95% relative  
 Altitude . . . . . <4570 m (15,000 ft)

**2-23. Bench Operation**

2-24. The instrument cabinet has plastic feet and a fold-away tilt stand for convenience in bench operation. (The plastic feet are shaped to ensure self-aligning of the instruments when stacked.) The tilt stand raises the front of the instrument for easier viewing of the control panel.

**2-25. Rack Mounting**

2-26. Instruments that are narrower than full rack width may be rack mounted using Hewlett-Packard sub-module cabinets. If it is desired to rack mount one Power Meter by itself, order half-module kit, HP Part Number 5061-0057. If it is desired to rack mount two Power Meters side by side, order the following items:

- a. Option 908 Rack Mounting Flange Kit—(For instruments without handles) HP Part Number 5061-9677.
- b. Option 913 Rack Mounting Flange Kit—(For instruments with handles) HP Part Number 5061-9771.

- c. Lock Link Kit—Kit consists of lock hardware and screws for joining instrument cabinets in several different configurations. Enough horizontal links (12 front, 6 rear) for three side-by-side joints (up to 4 instruments), and enough vertical links (4 front, 4 rear) to form two over/under joints (up to 3 instruments) HP Part Number 5061-0094.

2-27. Option 907 In addition to the rack mounting hardware, a front handle assembly (two provided) is also available for the Power Meter. The part number is HP 5061-9689.

**2-28. STORAGE AND SHIPMENT**

**2-29. Environment**

2-30. The instrument should be stored in a clean dry environment. The following environmental limitations apply to both storage and shipment:

Temperature . . . . . -40°C to +75°C  
 Humidity . . . . . <95% relative  
 Altitude . . . . . <7620 m (25,000 ft)

**2-31. Packaging**

**2-32. Original Packaging.** Containers and materials identical to those used in factory packaging are available through Hewlett-Packard offices. If the instrument is being returned to Hewlett-Packard for servicing, attach a tag indicating the type of service required, return address, model number, and full serial number. Also mark the container FRAGILE to assure careful handling. In any correspondence refer to the instrument by model number and full serial number.

**2-33. Other Packaging.** The following general instructions should be used for re-packaging with commercially available materials:

- a. Wrap the instrument in heavy paper or plastic. (If shipping to a Hewlett-Packard office or service center, attach a tag indicating the service required, return address, model number, and full serial number.)
- b. Use a strong shipping container. A double-wall carton made of 275-lb test material is adequate.
- c. Use enough shock-absorbing material (3 to 4-inch layer) around all sides of instrument to provide firm cushion and prevent movement in the container. Protect the control panel with cardboard.
- d. Seal the shipping container securely.
- e. Mark the shipping container FRAGILE to assure careful handling.

Table 2-2. Circuit Options

Assembly	Service Sheet	Jumper Functions
A-D Converter Assembly A3	8	The factory-installed jumpers provide a filtered dc RECORDER OUTPUT which corresponds to the average power input to the Power Sensor. If external filtering is desired, reconnect the jumpers to provide the optional unfiltered dc RECORDER OUTPUT as shown on Service Sheet 8.

Table 2-3. USA Standard Code for Information Interchange (ASCII)

BITS					0 <sub>00</sub>	0 <sub>01</sub>	0 <sub>10</sub>	0 <sub>11</sub>	1 <sub>00</sub>	1 <sub>01</sub>	1 <sub>10</sub>	1 <sub>11</sub>	NOTE 3
b <sub>7</sub>	b <sub>6</sub>	b <sub>5</sub>	Column→		0	1	2	3	4	5	6	7	
b <sub>4</sub>	b <sub>3</sub>	b <sub>2</sub>	b <sub>1</sub>	Row↓	0	1	2	3	4	5	6	7	
0	0	0	0	0	NUL	DLE	SP	0	@	P	`	p	
0	0	0	1	1	SOH	DC1	!	1	A	Q	a	q	
0	0	1	0	0	STX	DC2	"	2	B	R	b	r	
0	0	1	1	1	ETX	DC3	#	3	C	S	c	s	
0	1	0	0	0	EOT	DC4	\$	4	D	T	d	t	
0	1	0	1	1	ENQ	NAK	%	5	E	U	e	u	
0	1	1	0	0	ACK	SYN	&	6	F	V	f	v	
0	1	1	1	1	BEL	ETB	'	7	G	W	g	w	
1	0	0	0	0	BS	CAN	(	8	H	X	h	x	
1	0	0	1	1	HT	EM	)	9	I	Y	i	y	
1	0	1	0	0	LF	SUB	*	:	J	Z	j	z	
1	0	1	1	1	VT	ESC	+	;	K	[	k	{	
1	1	0	0	0	FF	FS	,	<	L	\	l		
1	1	0	1	1	CR	GS	-	=	M	]	m	}	
1	1	1	0	0	SO	RS	.	>	N	^	n	~	
1	1	1	1	1	SI	US	/	?	O	_	o	DEL	

NOTE 3
NOTE 1
NOTE 2

NOTE 1: HP-IB valid LISTEN addresses  
 NOTE 2: HP-IB valid TALK addresses  
 NOTE 3: Logic 1 = 0V

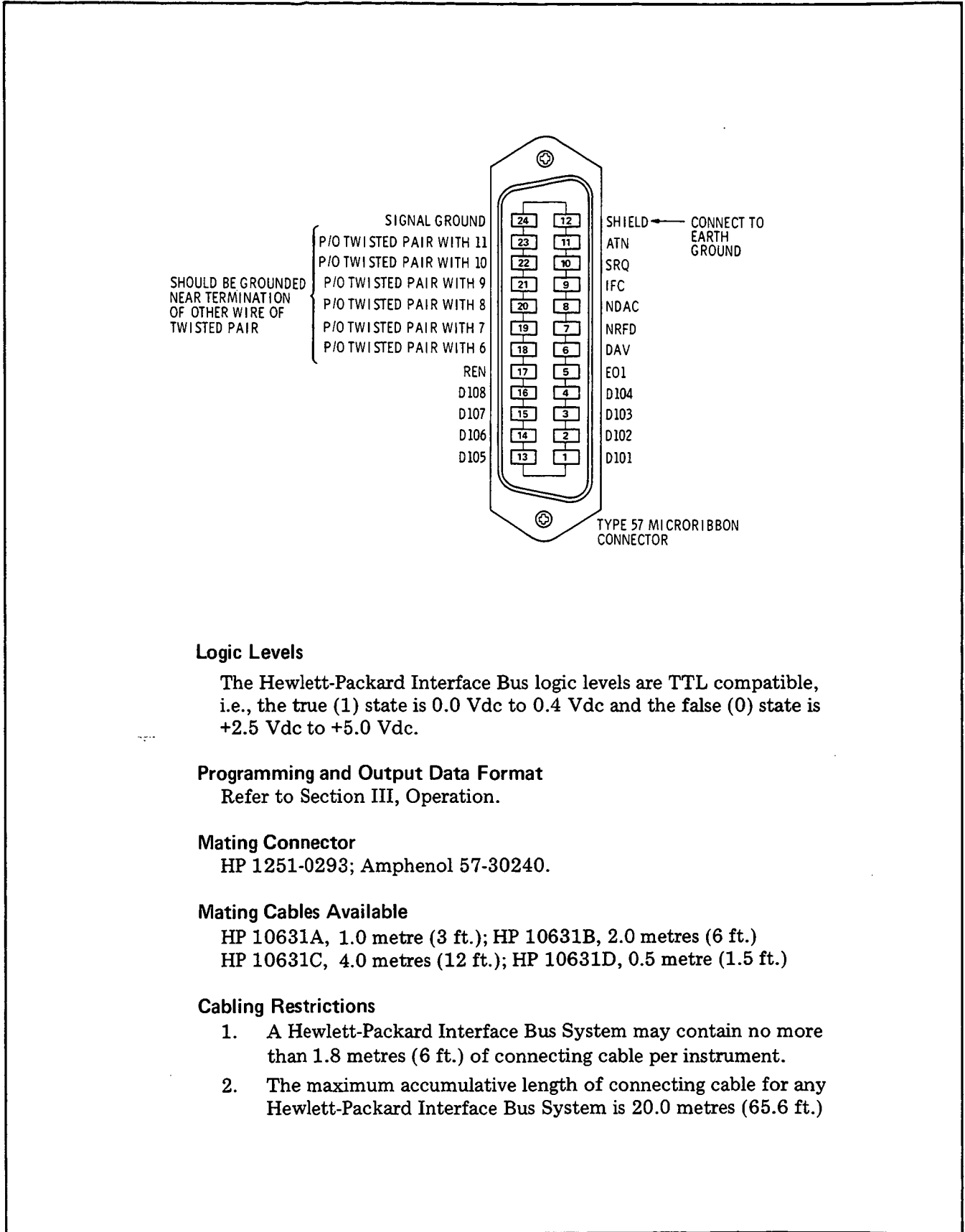

**Logic Levels**

The Hewlett-Packard Interface Bus logic levels are TTL compatible, i.e., the true (1) state is 0.0 Vdc to 0.4 Vdc and the false (0) state is +2.5 Vdc to +5.0 Vdc.

**Programming and Output Data Format**

Refer to Section III, Operation.

**Mating Connector**

HP 1251-0293; Amphenol 57-30240.

**Mating Cables Available**

HP 10631A, 1.0 metre (3 ft.); HP 10631B, 2.0 metres (6 ft.)  
 HP 10631C, 4.0 metres (12 ft.); HP 10631D, 0.5 metre (1.5 ft.)

**Cabling Restrictions**

1. A Hewlett-Packard Interface Bus System may contain no more than 1.8 metres (6 ft.) of connecting cable per instrument.
2. The maximum accumulative length of connecting cable for any Hewlett-Packard Interface Bus System is 20.0 metres (65.6 ft.)

Figure 2-3. Hewlett-Packard Interface Bus Connection

## SECTION III OPERATION

### 3-1. INTRODUCTION

3-2. This section provides complete operating information for the Power Meter. Included in the section are a description of all front- and rear-panel controls, connectors, and indicators (panel features), operator's checks, operating instructions, power measurement accuracy considerations, and operator's maintenance.

3-3. Since the power meter can be operated locally as well as remotely via the Hewlett-Packard Interface Bus (Option 022), the information in this section is arranged accordingly. All information unique to a particular operating configuration is designated as such; where no distinction is made, the information is applicable to both standard and optional instrument operation.

### 3-4. PANEL FEATURES

3-5. Front and rear panel features of the Power Meter are described in Figure 3-1. This figure contains a detailed description of the controls, connectors and indicators.

### 3-6. OPERATOR'S MAINTENANCE

3-7. The only maintenance the operator should normally perform is replacement of the primary power fuse located within Line Module Assembly A11. For instructions on how to change the fuse, refer to Section II, Line Voltage Selection.

#### CAUTION

*Make sure that only fuses with the required rated current and of the specified*

*type (normal blow, time delay, etc.) are used for replacement. The use of repaired fuses and the short-circuiting of fuse-holders must be avoided.*

### 3-8. OPERATOR'S CHECKS

3-9. A procedure for verifying the major functions of the Power Meter is provided in Figure 3-2. The procedure is divided into two parts: Local Operation and Remote Hewlett-Packard Interface Bus Operation. For a standard instrument it is only necessary to perform the Local Operation procedure. For units equipped with the remote option, the Local Operation procedure should be performed first to establish a reference against which remote operation can be verified. Information covering remote programming of the Power Meter is provided in the following paragraphs, and a Hewlett-Packard Interface Bus Verification Program is provided in Section VIII, Service.

### 3-10. LOCAL OPERATING INSTRUCTIONS

3-11. Figure 3-3 provides general instructions for operating the Power Meter via the front-panel controls.

#### WARNING

*Any interruption of the protective (grounding) conductor (inside or outside the instrument) or disconnecting the protective earth terminal is likely to make this instrument dangerous. Intentional interruption is prohibited.*

FRONT AND REAR PANEL FEATURES

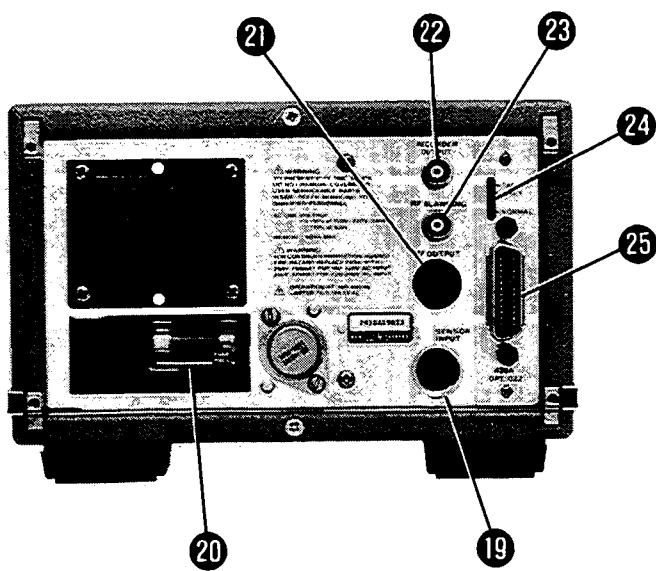
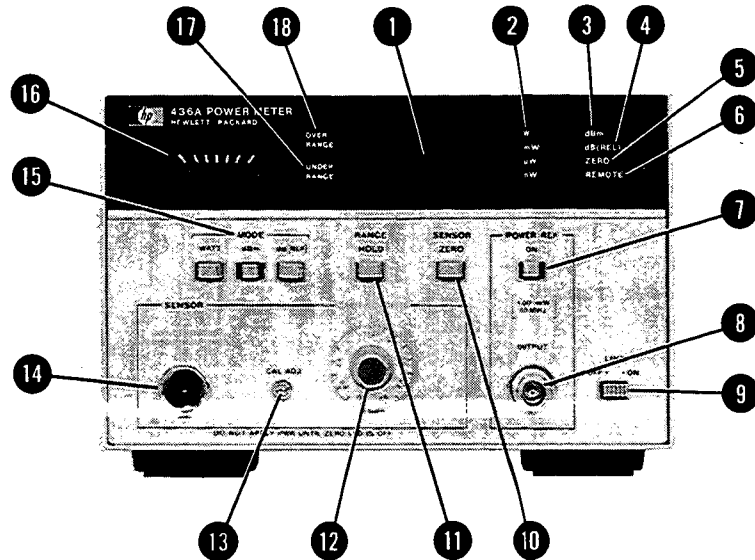

Figure 3-1. Front and Rear Panel Controls, Connectors, and Indicators (1 of 4)

## FRONT PANEL FEATURES

- 1 Digital Readout:** Indicates sign and decimal value of RF input power in Watts, dBm, or in dB relative to a stored reference.
- 2 Range Lamps (W, mW,  $\mu$ W, nW):** Enabled in WATT MODE. Light to indicate level of Digital Readout indication.
- 3 dBm:** Lights to indicate that dBm MODE is selected and Digital Readout indication is in dBm.
- 4 dB (REL):** Lights to indicate that dB RELATIVE MODE is selected and Digital Readout indication is in dB with respect to stored reference level.
- 5 ZERO:** Lights to indicate that power sensor auto-zero circuit is enabled and **23** RF BLANKING output is active.
- 6 REMOTE:** Associated with the Hewlett-Packard Interface Bus Option 022. Lights to indicate that front-panel switches are disabled and power meter operation is being controlled via remote interface.
- 7 POWER REF ON:** Alternate action pushbutton switch. When set to ON (in), enables **8** POWER REF OUTPUT.
- 8 POWER REF OUTPUT:** Enabled when **7** POWER REF switch is set to ON. Provides RF output of 1.00 mW  $\pm$  0.70% for system calibration.
- 9 LINE ON-OFF:** Alternate action pushbutton switch. Applies ac line power to Power Meter when set to ON (in).
- 10 SENSOR ZERO:** Spring-loaded pushbutton switch. When pressed, enables Power Sensor auto zero loop for a period of approximately 4 seconds (**5** ZERO lamp remains lit for the duration of this period).
- 11 RANGE HOLD:** Alternate action pushbutton switch. When set to off (out) allows Power Meter to auto-range as required to track changes in RF input power level. When set to on (in), locks Power Meter in last range enabled during autoranging.
- 12 CAL FACTOR %:** Rotary switch which changes the gain of the Power Meter amplifier circuits to compensate for mismatch losses and effective efficiency of the Power Sensor. A chart of CAL FACTOR % versus frequency is printed on each Power Sensor.
- 13 CAL ADJ:** Screwdriver adjustment for calibrating the Power Meter and any Power Sensor to a known standard.
- 14 SENSOR:** Provides input connection for Power Sensor via Power Sensor Cable.
- 15 MODE:** Interlocking pushbutton switches which configure the Power Meter to indicate average RF input power in watts, in dBm, or in dB with respect to a stored reference.

**WATT:** Alternate action pushbutton switch. When set to on (in), selects WATT Mode. (Power Meter is configured to indicate RF input power in watts, milliwatts, microwatts, or nanowatts.)

**dBm:** Alternate action pushbutton switch. When set to on (in), selects dBm Mode. (Power Meter is configured to indicate RF input power in dBm.)

**dB [REF]:** Spring-loaded pushbutton switch. When pressed, selects dB Relative Mode. (RF input power level displayed on **1** Digital Readout is stored as dB reference and **1**, Digital Readout changes to 0. Then Power Meter is configured to indicate changes in RF input level in dB with respect to stored reference.)

## NOTE

*In order to auto-zero the Power Sensor, no RF input power may be applied while the **5** ZERO lamp is lit. If any RF input power is applied, it will introduce an offset that will affect all subsequent measurements.*

## NOTE

*When the dB relative mode is selected, the WATT Mode or dBm Mode can be selected by pressing the **15** WATT MODE or dBm Mode switch and the power applied to the Sensor is displayed on the **1** Digital*  
(continued)

Figure 3-1. Front and Rear Panel Controls, Connectors, and Indicators (2 of 4)



FRONT AND REAR PANEL FEATURES

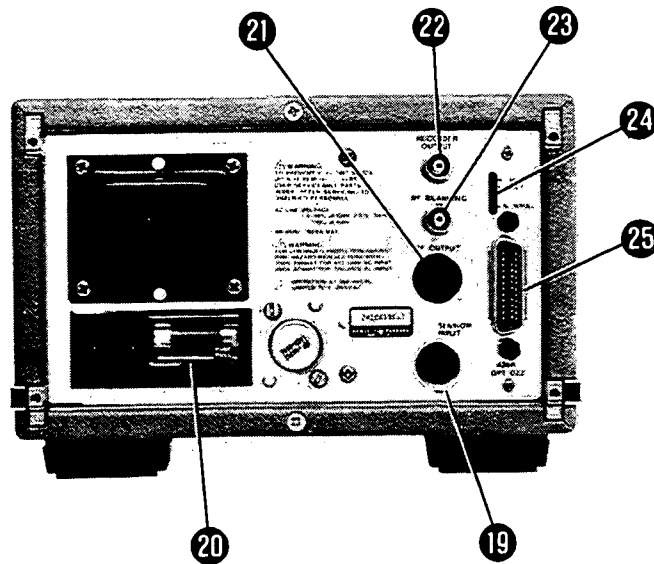
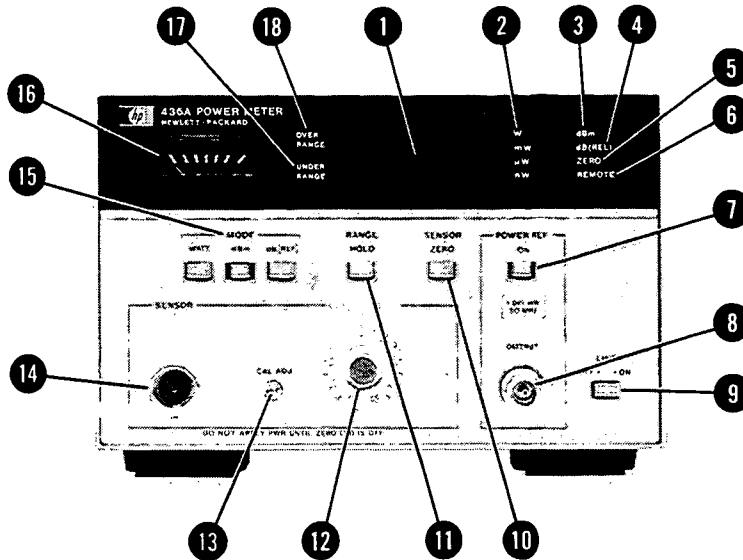

Figure 3-1. Front and Rear Panel Controls, Connectors, and Indicators (3 of 4)

**FRONT PANEL FEATURES (cont'd)**

(Note cont'd)

*Readout. To return to the dB Relative Mode without changing the stored reference, press the 15 WATT MODE or dBm MODE switch just enough to release the previously selected MODE switch. Do not press the 15 dB [REF] MODE switch or a new reference will be entered.*

**WARNING**

*Any interruption of the protective (grounding) conductor inside or outside the instrument or disconnecting of the protective earth terminal is likely to make the instrument dangerous. Intentional interruption is prohibited. (See Section II.)*

- 16 Auxiliary Meter:** Provides a linear display with respect to RF input power. For any given range, a full-scale meter indication corresponds to the highest indication that can be obtained on the Digital Display.
- 17 UNDER RANGE:** Lights to indicate that RF input power level is too small to be measured on selected range (autoranging disabled), or on Power Meter lowest range (autoranging enabled).
- 18 OVER RANGE:** Lights to indicate that RF input power level is too large to be measured on selected range (autoranging disabled), or on Power Meter highest range (autoranging enabled).
- REAR PANEL FEATURES**
- 19 SENSOR INPUT:** This rear panel input is wired in parallel with the front panel input 14 .
- 20 Line Power Module:** Permits operation from 100, 120, 220, or 240 Vac. The number visible in window indicates nominal line voltage to which instrument must be connected (see Figure 2-1). Protective grounding conductor connects to the instrument through this module.
- 21 POWER REF OUTPUT:** Takes the place of the front panel 8 POWER REF OUTPUT connector (Option 003 only).
- 22 RECORDER OUTPUT:** Provides a linear output with respect to the input power. +1.00 Vdc corresponds to a full scale 1 Digital Readout indication on the range selected (refer to Table 1-1). The minimum load which may be coupled to the output is 1 MΩ.
- 23 RF BLANKING:** Contact closure to ground when 10 SENSOR ZERO switch is pressed. May be used to remove RF input signal during automatic zeroing operation.
- 24 TALK ONLY/NORMAL:** Associated with Hewlett-Packard Interface Bus Option 022 only. NORMAL position configures the Power Meter as a basic talker. TALK ONLY position is normally used only when there is no controller connected to the interface bus (e.g., when Power Meter is interconnected with an HP 5150A recorder).
- 25 Interface Connector:** For Power Meter connection to remote interface Option 022.

Figure 3-1. Front and Rear Panel Controls, Connectors, and Indicators (4 of 4)

OPERATOR'S CHECKS

LOCAL OPERATION

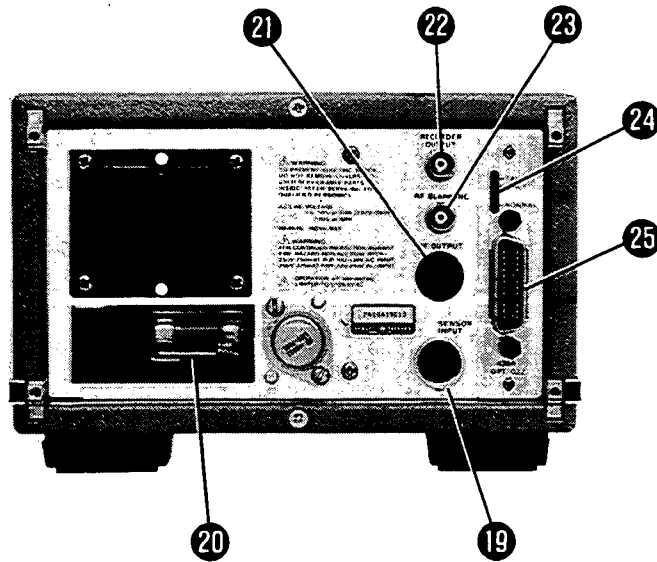
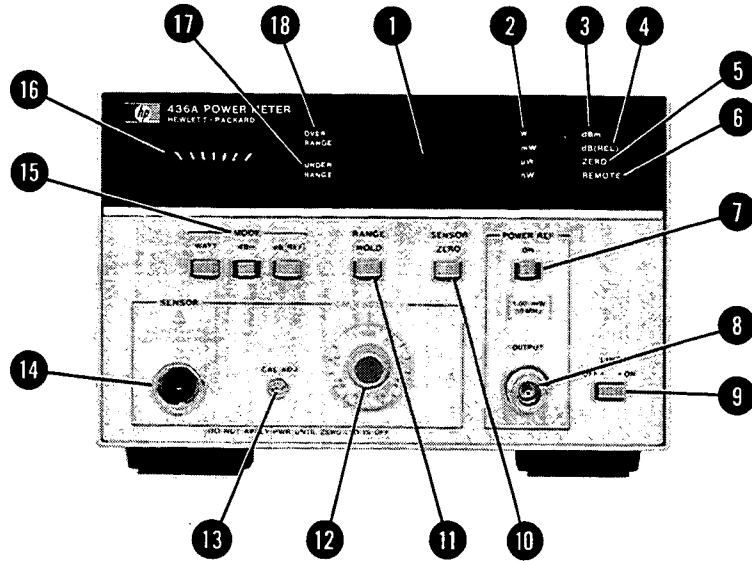

**WARNINGS**

*BEFORE CONNECTING LINE POWER TO THIS INSTRUMENT, ensure that all devices connected to this instrument are connected to the protective (earth) ground.*

*BEFORE SWITCHING ON THIS INSTRUMENT, ensure that the line power (mains) plug is connected to a three-conductor line power outlet that has a protective (earth) ground. (Grounding one conductor of a two-conductor outlet is not sufficient.)*

Figure 3-2. Operator's Checks (1 of 5)

**OPERATOR'S CHECKS**

**LOCAL OPERATION (cont'd)**

1. BEFORE SWITCHING ON THIS INSTRUMENT, ensure that the power transformer primary is matched to the available line voltage, the correct fuse is installed, and the safety precautions are taken. See Power Requirements, Line Voltage Selection, Power Cables, and associated warnings and cautions in Section II.

**NOTE**

*If Power Meter is equipped with the Hewlett-Packard Interface Bus option, unplug data bus cable from connector J7 on rear panel before performing this procedure. When data bus cable is unplugged, Power Meter is automatically configured for Local operation via front-panel controls.*

**CAUTION**

*DO NOT TWIST the body of the power sensor when connecting or disconnecting it to other instruments. Twisting may cause major damage to the power sensor electrical circuits.*

2. Connect the Power Sensor to the Power Meter with the Power Sensor Cable.
3. Connect the Power Sensor to the **8** POWER REF OUTPUT connector.
4. Connect the Power Cable to the power outlet and **20** Line Power Module receptacle, and set the **9** LINE switch to ON (in).
5. Set the remaining Power Meter switches as follows:

- 12** CAL FACTOR% . . . . . Set to reference calibration factor.
- 7** POWER REF . . . . . off (out)
- 15** MODE . . . . . WATT
- 11** RANGE HOLD . . . . . off (out)

**NOTE**

*Perform steps 6 through 19 only if Power Meter is connected to 8481A, 8482A, or 8483A Power Sensor. If Power Meter is connected to 8481H or 8482H Power Sensor, proceed to step 20.*

6. Press and hold the **10** SENSOR ZERO switch until the digital readout stabilizes. While the switch is held depressed, verify that the **5** ZERO lamp is lit and that the **23** RF BLANKING output is  $0.0 \pm 0.4V$ .
7. Release the **10** SENSOR ZERO switch and verify that the **5** ZERO lamp remains lit for approximately four seconds. When the **5** ZERO lamp goes out, verify that the **1** Digital Readout indicates  $0.00 \pm 0.02 \mu W$ .
8. Set the **11** RANGE HOLD and **7** POWER REF switches to ON (in). Verify that the **18** OVER-RANGE lamp lights and that the **1** Digital Readout blanks ( $1\_ \_ \mu W$ ).
9. Set the **11** RANGE HOLD switch to off (out). Verify that the Power Meter autoranges to the 1 mW range and that the **18** OVER RANGE lamp goes out.
10. Adjust the **13** CAL ADJ control so that the **1** Digital Readout indicates 1.000 mW. Verify that the pointer on the **16** Auxiliary Meter is aligned between the last two marks, and that the **22** RECORDER OUTPUT is approximately 1.000 Vdc.

Figure 3-2. Operator's Checks (2 of 5)

OPERATOR'S CHECKS

LOCAL OPERATION (cont'd)

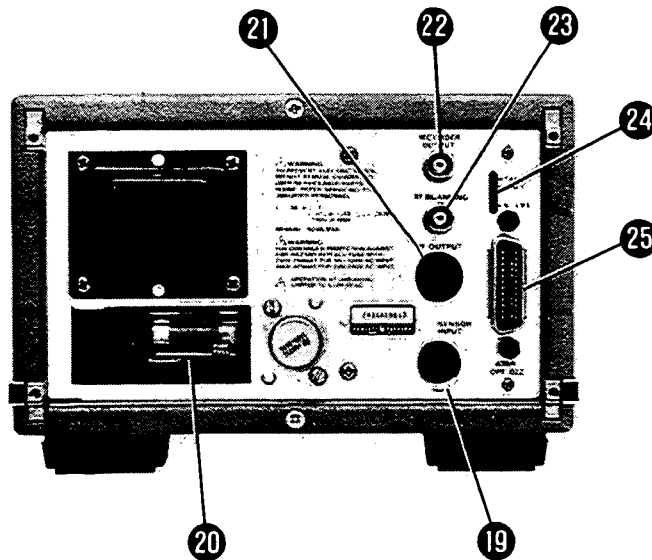
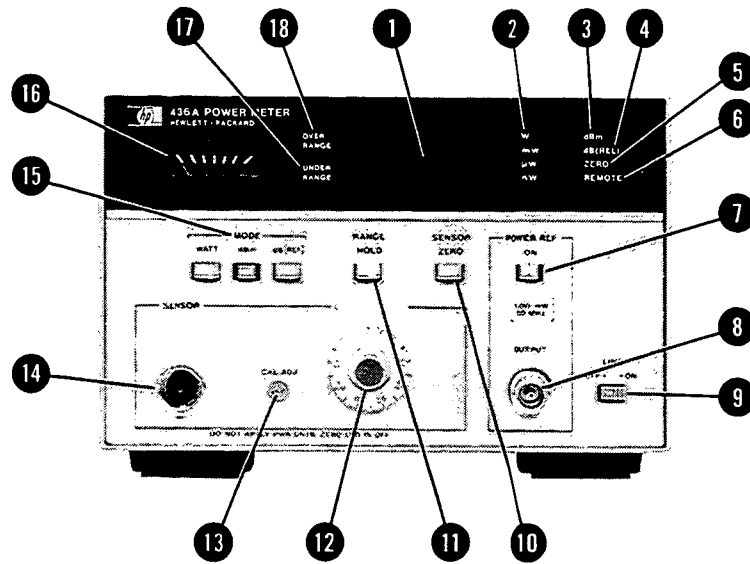

NOTE

Underscore (    ) indicates blanked digit.

11. Rotate the **12** CAL FACTOR % switch through its range and verify that the **1** Digital Readout indication increases slightly for each successive step. Then return the **12** CAL FACTOR % switch to 100.

Figure 3-2. Operator's Checks (3 of 5)

## OPERATOR'S CHECKS

## LOCAL OPERATION (cont'd)

12. Set the 15 dBm MODE switch to on (in) and verify that the 1 Digital Readout indicates  $-0.0 \pm 0.01$  dBm.
13. Set the 11 RANGE HOLD switch to on (in) and the 7 POWER REF switch to off (out). Verify that the 17 UNDER RANGE lamp lights and that the 1 Digital Readout blanks ( $-1\_ \_ \text{ dBm}$ ).
14. Set the 11 RANGE HOLD switch to off (out) and verify that the 1 Digital Readout blanked indication changes to  $-3\_ \_ \_$ . The new indication verifies that the Power Meter has autoranged to the most sensitive dBm range.
15. Set the 11 RANGE HOLD and 7 POWER REF switches to ON (in). Verify that the 18 OVER RANGE lamp lights and that the 1 Digital Readout blanked indication changes to  $-1\_ \_ \_$ .
16. Set the 11 RANGE HOLD switch to off (out) and verify that the 1 Digital Readout indicates  $-0.00 \pm 0.01$  dBm. This new indication verifies that the Power Meter has autoranged properly.
17. Adjust the 13 CAL ADJ control fully counterclockwise and verify the 1 Digital Readout is not 0.00 dBm ( $-1.1$  to  $-2.0$  dBm typical).
18. Press the 15 dB [REF] MODE switch and verify that the 3 dBm lamp goes out, the 4 dB (REL) lamp lights, and the 1 Digital Readout changes to  $-0.00$ . This step verifies that the Power Meter can store a dB reference value and indicate RF input power levels in dB with respect to the stored reference.
19. Set the 15 WATT Mode switch to on (in) and readjust the 13 CAL ADJ control so that the 1 Digital Readout indicates 1.000 mW.

**NOTE:** Steps 20 through 28 are performed in lieu of steps 6 through 19 when the Power Meter is connected to an 8481H or an 8482H Power Sensor.

20. Press and hold the 10 SENSOR ZERO switch until the 1 Digital Readout stabilizes. While the switch is held pressed, verify that the 5 ZERO lamp is lit and that the 23 RF BLANKING output is  $0.0 \pm 0.4$  V.
21. Release the 10 SENSOR ZERO switch and verify that the 5 ZERO lamp remains lit for approximately four seconds. When the 5 ZERO lamp goes out, verify that the 1 Digital Readout indicates  $0.00 \pm 0.02$  mW.
22. Set the 7 POWER REF switch to ON (in) and adjust the 13 CAL ADJ control so that the 1 Digital Readout indicates 1.000 mW. Verify that the pointer on the 16 Auxiliary Meter is aligned between the last two marks, and that the 22 RECORDER OUTPUT is approximately 1.000 Vdc.
23. Rotate the 12 CAL FACTOR % switch through its range and verify that the 1 Digital Readout increases slightly for each successive step. Then return the 12 CAL FACTOR % switch to 100.
24. Set the 15 dBm MODE switch to on (in) and verify that the 1 Digital Readout indicates  $-0.00 \pm 0.01$  dBm.
25. Set the 7 POWER REF switch to off (out). Verify that the 17 UNDER RANGE lamp lights and that the 1 Digital Readout blanks ( $-1\_ \_ \_ \text{ dBm}$ ).

Figure 3-2. Operator's Checks (4 of 5)

OPERATOR'S CHECKS

LOCAL OPERATION (cont'd)

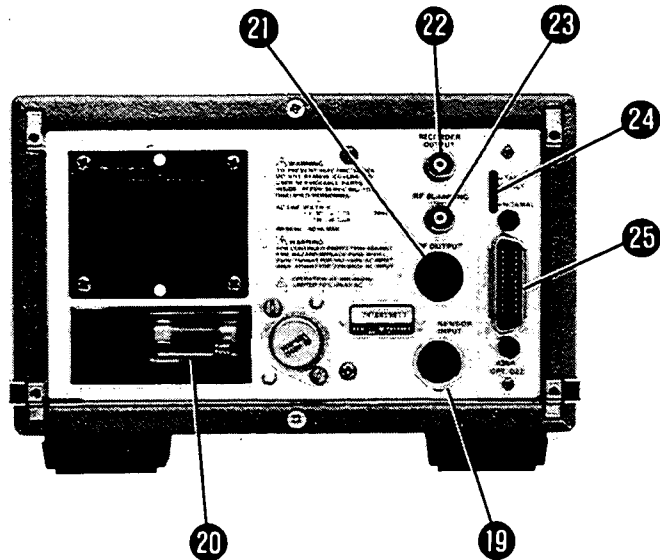
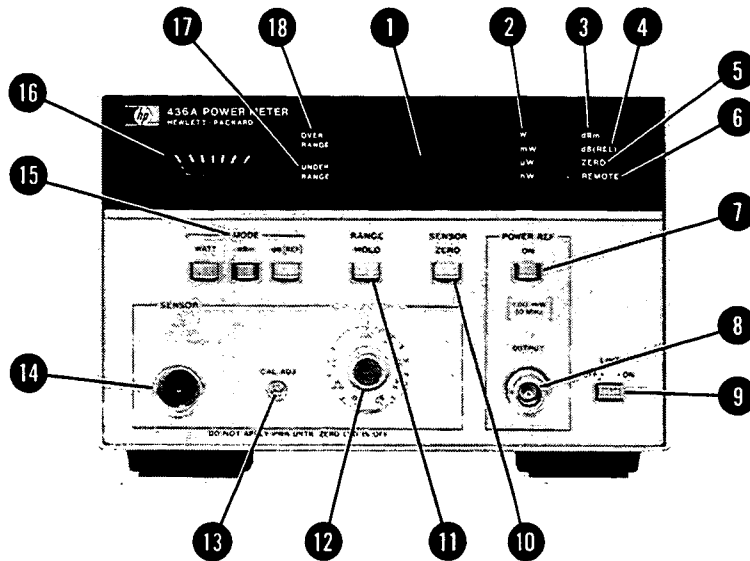

26. Set the **7** POWER REF switch to ON (in) and adjust the **13** CAL ADJ control fully counterclockwise and verify the **1** Digital Readout is not 0.00 dBm (-1.1 to -2.0 dBm typical).
27. Press the **15** dB [REF] Mode switch and verify that the **3** dBm lamp goes out, the **4** dB (REL) lamp lights, and the **1** Digital Readout changes to -0.00. This step verifies that the Power Meter can store a dB reference value and indicate input power levels in dB with respect to the stored reference.
28. Set the **15** WATT Mode switch to on (in) and readjust the **13** CAL ADJ control so that the **1** Digital Readout indicates 1.000 mW.

Figure 3-2. Operator's Checks (5 of 5)

### OPERATING INSTRUCTIONS

#### LOCAL OPERATION

1. BEFORE SWITCHING ON THIS INSTRUMENT, ensure that the power transformer primary is matched to the available line voltage, the correct fuse is installed, and safety precautions are taken. See Power Requirement, Line Voltage Selection, Power Cables, and associated warnings and cautions in Section II.

#### NOTE

*If Power Meter is equipped with the Hewlett-Packard Interface Bus Option, either unplug data bus cable from connector J7 on rear panel or program Power Meter for Local operation as described under Operating Instructions paragraph.*

**CAUTION**

*DO NOT TWIST the body of the power sensor when connecting or disconnecting it to other instruments. Twisting may cause major damage to the power sensor's electrical circuits.*

2. Connect the Power Sensor to the Power Meter with the Power Sensor Cable.
3. Connect the Power Cable to the power outlet and 20 Line Power Module receptacle and set the 9 LINE ON-OFF switch to ON (in).
4. Set the remaining Power Meter switches as follows:

- |    |                        |           |
|----|------------------------|-----------|
| 12 | CAL FACTOR % . . . . . | 100       |
| 7  | POWER REF . . . . .    | off (out) |
| 15 | MODE . . . . .         | WATT      |
| 11 | RANGE HOLD . . . . .   | off (out) |

5. Press and hold the 10 SENSOR ZERO switch and wait for the 1 Digital Readout to stabilize. Then verify that the 5 ZERO lamp is lit and that the 1 Digital Readout indicates 0.00 ±0.02.

#### NOTE

*When auto-zeroing the Power Sensor, no RF input power may be applied while the ZERO lamp is lit. If any RF input power is applied, it will introduce an offset that will affect subsequent measurements.*

6. Release the 10 SENSOR ZERO switch and wait approximately 4 seconds for the 5 ZERO lamp to go out.
7. Connect the Power Sensor to the 8 POWER REF OUTPUT connector and set the 7 POWER REF switch to ON (in). Then adjust the 13 CAL ADJ control so that the 1 Digital Readout indicates 1.000 mW.
8. Set the 7 POWER REF switch to off (out) and disconnect the Power Sensor from the 8 POWER REF OUTPUT connector.
9. Locate the calibration curve on the Power Sensor cover and determine the CAL FACTOR for the measurement frequency; set the Power Meter 12 CAL FACTOR % switch accordingly.

**CAUTION**

*See Operating Precautions in the Power Sensor Operating and Service Manuals for maximum power levels which may be safely coupled to this system. Levels which exceed the limits may damage the Power Sensor, Power Meter or both.*

10. Set the 15 MODE and 11 RANGE HOLD switches for desired operation and connect the Power Sensor to the RF source.

Figure 3-3. Operating Instructions (1 of 3)



**OPERATING INSTRUCTIONS**  
**HEWLETT-PACKARD INTERFACE BUS (HP-IB) OPERATION**

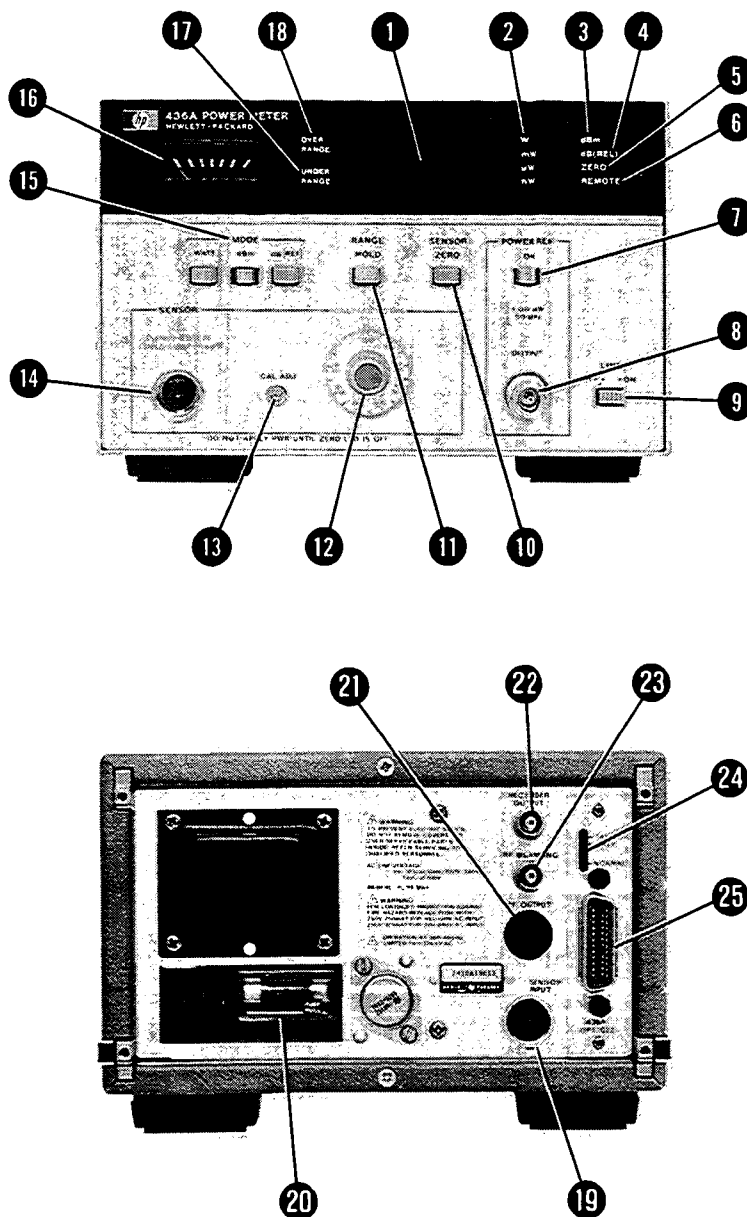

**WARNINGS**

*BEFORE CONNECTING LINE POWER TO THIS INSTRUMENT, ensure that all devices connected to this instrument are connected to the protective (earth) ground.*

*BEFORE SWITCHING ON THIS INSTRUMENT, ensure that the line power (mains) plug is connected to a three-conductor line power outlet that has a protective (earth) ground. (Grounding one conductor of a two-conductor outlet is not sufficient.)*

**Figure 3-3. Operating Instructions (2 of 3)**

**OPERATING INSTRUCTIONS**

**HP-IB OPERATION (cont'd)**

1. BEFORE SWITCHING ON THIS INSTRUMENT, ensure that the power transformer primary is matched to the available line voltage, the correct fuse is installed, and safety precautions are taken. See Power Requirement, Line Voltage Selection, Power Cables, and associated warnings and cautions in Section II.

**CAUTION**

*DO NOT TWIST the body of the power sensor when connecting or disconnecting it to other instruments. Twisting may cause major damage to the power sensor's electrical circuits.*

2. Connect the Power Sensor to the Power Meter with the Power Sensor Cable.
3. Connect the Power Meter to the Remote Interface 25.
4. Connect the Power Cable to the power outlet and 20 Line Power Module receptacles and set the 9 LINE ON-OFF switch to ON (in).
5. Set the Power Meter 12 CAL FACTOR % switch to 100 and the 7 POWER REF switch to off (out).
6. Set the remote enable input to the Power Meter to logical 1 (0.0 ± 0.4 Vdc) and program the Power Meter as follows:

Mode . . . . .	WATT
Range . . . . .	AUTO
10 SENSOR ZERO . . . . .	ON
12 CAL FACTOR % . . . . .	enabled

7. Wait for the 1 Digital Readout to stabilize, then verify that the 5 ZERO lamp is lit and that the 1 Digital Readout indicates 0.00 ± 0.02.

**NOTE**

*When auto-zeroing the Power Sensor, no RF input power may be applied while the 5 ZERO lamp is lit. If any RF input power is applied, it will introduce an offset that will affect subsequent measurements.*

8. Program the 10 SENSOR ZERO function to off by programming one of the other modes (WATT, dBm or dB Ref) and wait approximately 4 seconds for the 5 ZERO lamp to go out.
9. Connect the Power Sensor to the 8 POWER REF OUTPUT connector and set the 7 POWER REF switch to ON (in). Then adjust the 13 CAL ADJ control so that the 1 Digital Readout indicates 1.000 mW.
10. Set the 7 POWER REF switch to off (out) and disconnect the Power Sensor from the 8 POWER REF OUTPUT connector.
11. Locate the calibration curve on the Power Sensor to cover and determine the CAL FACTOR for the measurement frequency; set the Power Meter 12 CAL FACTOR % switch accordingly.

**CAUTION**

*See Operating Precautions in the Power Sensor Operating and Service Manuals for maximum power levels which may be safely coupled to this system. Levels which exceed the limits may damage the Power Sensor, Power Meter or both.*

12. Program the Power Meter to the desired Mode and Range, select the triggering most appropriate to the type of measurements anticipated, and connect the Power Sensor to the RF source.

**Figure 3-3. Operating Instructions (3 of 3)**

## 3-12. HEWLETT-PACKARD INTERFACE BUS REMOTE OPERATION

### NOTE

*For a quick and easy programming guide see Figure 3-8; for detailed information study paragraphs 3-12 through 3-61.*

3-13. Hewlett-Packard Interface Bus (HP-IB) Option 022 adds remote programming and digital output capability to the Power Meter. For further information about the HP-IB, refer to IEEE Standard 488 and the Hewlett-Packard Catalog. Power Meter compatibility, programming, and data format is described in detail in the paragraphs which follow.

### 3-14. Compatibility

3-15. The Power Meter controls that can be programmed via the Hewlett-Packard Interface Bus are the MODE and SENSOR ZERO switches. The controls not programmable are the POWER REF and LINE switches. The CAL FACTOR % switch can be enabled and disabled via the interface bus but, when enabled, the calibration factor entered at the front-panel of the Power Meter is used.

3-16. In addition, specific ranges can be set and various triggering options are available to the programmer. This will be described in detail later.

3-17. The programming capability of the Power Meter will be described in terms of the twelve bus messages found in Table 3-1.

### 3-18. Data Messages

3-19. The Power Meter communicates on the bus primarily through data messages. It receives data messages that tell it what range to use, what mode to use, whether or not cal factor should be enabled, and what the measurement rate should be. It sends data messages that tell the measurement value, the mode and range the value was taken at, and what the instrument's status (see Table 3-4) was when it took the measurement.

3-20. Table 3-2 outlines the key elements involved in making a measurement. Indeed the Power Meter can be programmed to make measurements via the HP-IB by following only the sequence suggested in the table, and briefly referring to Tables 3-3, 3-4, (input and output data), and Fig. 3-8. However, to take advantage of the programming flexibility built into the Power Meter and minimize the time it

takes to make a valid measurement, study the rest of the information in this section.

### 3-21. Receiving Data Messages

3-22. The Power Meter is configured to listen (receive data) when the controller places the interface bus in the command mode (ATN and REN lines low; IFC line high) and outputs listen address “—” (minus sign). The Power Meter then remains configured to listen (accept programming inputs when the interface bus is in the data mode) until it is unaddressed by the controller. To unaddress the Power Meter, the controller can either send the Abort Message (set the IFC line low) or send the Local Message (set the REN line high), or it can place the interface bus in the command mode and generate a universal unlisten command.

3-23. **Data Input Format.** The Power Meter does not require any particular data input format. It is capable of responding to each of the programming codes listed in Table 3-3 on an individual basis. Because it responds to these codes in the order it receives them, we recommend that the code for measurement rate be sent last.

3-24. **Program Codes.** Table 3-3 lists the program codes that the Power Meter responds to and the functions that they enable. In the listen mode, the Power Meter can handshake in 0.5  $\mu$ s. The time required for the Power Meter to respond to the programming command, however, depends on where the Power Meter is in the operating program (see Figure 3-6). The overall worst case time for Power Meter response to a programming command is 2.5 seconds, the minimum response time is approximately 100 microseconds.

### NOTE

*In addition to the program codes listed in Table 3-3, Power Meter operation will be affected by all other program codes shown in columns 2, 3, 4, and 5 of Table 2-2, except (SP!"#\$%&\*). Thus care should be taken to address the Power Meter to unlisten before sending these programming commands to other instruments on the interface bus.*

3-25. **Programming the Range.** Remote range programming is slightly different than Local range selection. For Local operation the Power Meter auto-ranges. For Remote operation, the program codes have provision for direct selection of the de-

Table 3-1. Message Reference Table

Message and Identification	Applicable	Command and Title	Response
Data	Yes	T3 Talker, L2 Listener, AH1 Acceptor Handshake SH1 Source Handshake.	Power Meter changes mode, range, measurement rate, and Cal Factor enable or disable. It outputs status and measurement data.
Trigger (DT0)	No	Device Trigger	The Power Meter does not respond to a Group Execute Trigger. However, remote trigger capability is part of the Data message (measurement rate).
Clear (DC4)	Yes No	DCL Device Clear SDC Selected Device Clear	Upon receipt of DCL command, Power Meter functions are set for Watt Mode, Auto Range, Cal Factor Disable and Measurement rate Hold.
Remote (RL2) <sup>1</sup>	Yes	REN Remote Enable	Power Meter goes to remote when addressed to listen, and REN is true (low).
Local (RL2) <sup>1</sup>	Yes No	REN Remote Disable GTL Go to Local	Power Meter goes to local when REN is false (high). Power Meter does not respond to GTL command.
Local Lockout (RL2) <sup>1</sup>	No	REN Remote Disable	Power Meter does not respond to LLO command.
Clear Lockout/ Set Local (RL2) <sup>1</sup>	Yes	REN Remote Disable	Returns all devices on bus to local operation.
Pass Control/Take Control (C0)	No	Controller	Power Meter cannot act as bus controller.
Require Service (SR0)	No	SRQ Service Request	Power Meter does not request service.
Status Byte	No	SPE Serial Poll Enable SPD Serial Poll Disable	Power Meter does not respond to a Serial Poll
Status Bit (PP0)	No	PP Parallel Poll	Power Meter does not respond to a parallel poll.
Abort	Yes	IFC Interface Clear	Power Meter stops talking or listening.

<sup>1</sup>The 436A does not have complete RL2 capability since it cannot process the Go-To-Local (GTL) message.

#### NOTE

Complete HP-IB capability as defined in IEEE Std. 488 is AH1, C0, DC2, DT0, LE0, PP0, RL2, SH1, SR0, T3, TE0.

Table 3-2. Measurement Sequence

MEASUREMENT SEQUENCE

- Event 1** {controller talk and Power Meter listen} , {Program Codes}
- └ See controller manual. Power Meter Listen address factory set to “-” (see Tables 2-1 and 2-2). e.g., CMD “?U-”; “9D+V” wrt “pmrd”, “9D+V”
  - └ Program codes to configure one or more of the following (see Table 3-3):
    1. Range
    2. Remote mode (Watt, dBm, dB [Ref])
    3. Cal Factor
    4. Measurement Rate (and trigger)
- Event 2** Response time for meter’s digital (operating program) circuitry (see Table 3-5 and Figures 3-5 and 3-6).
- Event 3** Meter takes measurement; data available.
- Event 4** Additional delay to allow analog circuits to settle; necessary only if on Range 1 (most sensitive) or if settling time measurement rates are not being used (see Figure 3-4). Here are some suggestions:\*
1. Load reading into controller (event five) and check data string for range (look at character number 1 or check measured value).
  2. If Power Meter is on Range 1, wait 10 seconds and take another reading.
  3. If settling time measurement rates are being used and meter is *not* on Range 1, use the first reading.
  4. If settling time measurement rates are *not* being used, determine the range and branch to an appropriate delay: Range 2, one second; Ranges 3-5, 0.1 second.
- Event 5** {universal unlisten, controller listen and Power Meter talk} , {variable name}
- └ See controller manual. Power Meter Talk address factory set to “M” (see Tables 2-1 and 2-2).

\*There are other ways to ensure that readings are not affected by analog circuit settling time. Also, these recommended delays are worst case. A thorough understanding of the material in this section will allow you to optimize measurement time for your particular application. For example, if the power level is not changing, the controller can average at least two consecutive readings to see if the result is still settling.

EXAMPLE PROGRAM SEQUENCE:

Line 1 {controller talk and power meter listen} , “9D+T”

- └ Measurement Rate: Trigger with settling time.
- └ Cal Factor Disable (100%)
- └ dBm Mode
- └ Auto Range

Line 2 {universal unlisten, controller listen and power meter talk} , {variable name}

- └ Power meter outputs measured value to controller.

Line 3 { Controller checks value in variable for Range 2 threshold (e.g., < -20 dBm for Model 8482A Power Sensor). If value is below threshold, program branches to line 4. If value is above threshold, program branches to line 5. }

Line 4 {wait 10 seconds, then go to line 1} .

Line 5 {continue} .

**Table 3-3. Hewlett-Packard Interface Bus Input Program Codes**

Function	Program Codes	
	ASC II	DECIMAL
<b>Range</b>		
Least sensitive	5	53
	4	52
	3	51
	2	50
Most sensitive	1	49
Auto	9	57
<b>MODE</b>		
Watt	A	65
dB (Rel)	B	66
dB [Ref]	C	67
dBm	D	68
Sensor auto-zero	Z	90
<b>CAL FACTOR</b>		
Disable (100%)	+	43
Enable (front-panel switch setting)	-	45
<b>Measurement Rate</b>		
Hold	H	72
Trigger with settling time	T	84
Trigger, immediate	I	73
Free Run at maximum rate	R	82
Free Run with settling time	V	86

sired range as well as for selection of the autorange function.

**3-26. Programming the Mode.** Remote mode programming is similar to Local mode selection. The sequence shown in Example 1 is recommended for taking dB (Rel) readings from a dB [Ref] reference.

**3-27. Programming Auto-Zero.** The Power Meter is remotely zeroed the same way it is zeroed in local. Example 2 shown on the next page outlines the

**EXAMPLE 1 (dB Rel/dB Ref)**

1	{controller talk and Power Meter listen}, "CT"	Sets reference at present RF input level.
2	{controller talk and Power Meter listen}, "BT"	Takes first reading relative to set reference
3	{universal unlisten, controller listen and Power Meter talk}, {Variable name}	Power Meter outputs reading to controller
4	{controller talk and Power Meter listen}, "T"	Takes subsequent readings
5	{universal unlisten, controller listen and Power Meter talk}, {Variable name}	Power Meter outputs reading to controller

program steps that should be written. Specific examples are provided later in this Section. (Refer to Tables 3-3 and 3-4 for Power Meter input and output strings. Refer to controller manual for programming syntax.)

**3-28. Programming Cal Factor.** While the setting of the front panel CAL FACTOR switch cannot be remotely changed, the programmer does have a choice. If CAL FACTOR enable is programmed, then the Power Meter uses the Cal Factor set by the switch. If CAL FACTOR Disable is programmed, then the Power Meter uses a Cal Factor of 100%, but the program can correct for cal factor by computing the corrected reading from the actual reading and the cal factor (a Cal Factor table must be stored in an array).

**3-29. Programming Measurement Rate.** A feature that is only available via remote programming is selection of standby, triggered, or free running operation of the Power Meter. (During Local operation, the Power Meter is allowed to free run with approximately 133 milliseconds allowed for settling time between measurements.) The specific remote triggering capabilities are:

a. **Hold (H)** — when the power meter is programmed to Hold, it is inhibited from taking measurements and from outputting data. Thus, it is set to a predetermined reference condition from which a measurement can be triggered synchronously to some external event.

b. **Trigger Immediate (I)** — this programming command directs the Power Meter to make one measurement and output the data in the minimum possible time, then to go into Hold until the next triggering command is received. It does not allow settling time prior to the measurement.

c. **Trigger with Delay (T)** — this trigger command is identical to the trigger immediate command except that it causes the Power Meter to execute a settling-time delay subroutine before taking a measurement and outputting data.

**Receiving Data Messages (cont'd)**

d. **Free run at maximum rate (R)** — this programming command is normally used for asynchronous operation of the Power Meter. It directs the Power Meter to continuously take measurements and output data in the minimum possible time. It does not allow settling time prior to each measurement.

e. **Free run with delay (V)** — this programming command is identical to the previous command except that it causes the Power Meter to execute a settling-time delay subroutine prior to each measurement.

3-30. When programming the Power Meter for synchronous triggered operation, there are two factors that the programmer must consider to ensure the validity of the output measurement data. The first factor is the time that it takes the Power Meter to respond to a full scale change in input power level. A typical Power Meter response curve is shown in Figure 3-4. By comparing this curve with the measurement timing cycle shown in Figure 3-5 and summarized in Table 3-5, the validity of the Power Meter output can be tabulated according to operating range and triggering interval versus change in input power level. A general summary of this information is as follows:

a. When the Power Meter is programmed for trigger with settling time operation, sufficient time is provided for the Power Meter to settle to the input power level on all ranges except Range 1 (most sensitive range). On Range 1 approximately 10 seconds (9–10 measurements) are required for the Power Meter to settle to the input power level.

b. When the Power Meter is programmed for trigger immediate operation, the desired amount of settling time can be incorporated into the program.

**3-31. Programming the Local to Remote Mode Change.** The second factor that must be considered when programming the Power Meter for synchronous triggered operation is whether the first trigger is sent immediately after terminating local operation. As illustrated in Figure 3-6, the Power Meter will not respond to the first trigger following a local to remote transition until it completes the previously initiated measurement and display cycle. Thus, the first data output of the Power Meter may not be valid. The options available to the programmer are:

1. Send a trigger command (Data Message) and discount the first data output. Upon outputting the data, the Power Meter will go to Hold and operate synchronously starting with the next trigger command.
2. Wait approximately 2.5 seconds after placing the Power Meter in remote and sending the first program trigger command (Data Message).
3. Send a Clear Message (DCL) immediately after placing the Power Meter in remote. This will restart the Power Meter operating program.

**3-32. Sending Data Messages from the Power Meter**

3-33. The **24** TALK ONLY/NORMAL switch (see Figure 3-3) enables the Power Meter to func-

**EXAMPLE 2 (Auto Zero)**

- 1 Remove RF power from power sensor (or set it at least 20 dB below the lowest range of the sensor).
- 2 {controller talk and Power Meter listen} , "Z1T" Send zero trigger program codes.
- 3 {universal unlisten, controller listen and Power Meter talk} , {variable name} Read measured value data from meter (characters 4, 5, 6, and 7).
- 4 If absolute value of measured data is not  $\leq 2$  ( $0000 \pm 0002$ ) then branch to step 2; if it is, then continue. (Although this step averages three seconds, it may take as long as 10 seconds to execute.)
- 5 {controller talk and Power Meter listen} , "9 + DI" Send normal measurement mode program codes.
- 6 {universal unlisten, controller listen and Power Meter talk} , {variable name} Read status character (number 0) from meter's output data string.
- 7 Check status character for an auto zero loop enabled condition (character 0  $\geq$  decimal 84). If loop is enabled then branch to step 5. If not, then continue. (This step takes approximately four seconds to execute.)

**Sending Data Messages (cont'd)**

tion as a basic talker or in the talk only mode. If the basic talker function is selected, the Power Meter is configured to talk when the controller places the interface bus in the command mode and outputs talk address M. The Power Meter then remains configured to talk (output data when the interface bus is in the data mode), until it is unaddressed to talk by the controller. To unaddress the Power Meter, the controller can either send an Abort Message (generate an interface clear), or it can place the interface bus in the command mode and output a new talk address or a universal untalk command. Examples of addressing and unaddressing the Power Meter to talk are provided in Table 3-2 and Figure 3-8.

**3-34. Talk Only Mode.** When the Power Meter functions in the Talk Only Mode, it is automatically configured to TALK when the interface bus is in the Data Mode and there is at least one listener. Since there can only be one talker at a time per interface bus, this function is normally selected only when there is no controller connected to the system (e.g., when the Power Meter is interconnected to an HP 5150A recorder).

**3-35. Output Data Format.** The output data format of the Power Meter is shown and described in Table 3-4.

**3-36.** The output data is a fourteen character string that is provided once at the end of each measurement cycle. It is a good idea to read at least part of this string into the controller after each measurement cycle, even if it will not be used. This will avoid the possibility of incorrect data being read after some future measurement.

**3-37.** The string begins with a status character and ends with a carriage return and a line feed. Measured value is formatted as a real constant: plus or minus four digits (leading zeros not suppressed) followed by an exponential multiplier. The decimal point is not provided because it is understood that it follows the four "measured value" digits. The two-digit exponent is always negative.

**3-38. Data Output Time.** Figure 3-6 provides a simplified flow chart of Power Meter operation. As shown in the figure, the Power Meter operates according to a stored program and can only output

**Table 3-4. Hewlett-Packard Interface Bus Output Data String**

Definition		Character		
		ASC II	Decimal	
S T A T U S	Measured value valid	P	80	
	Watts Mode under Range	Q	81	
	Over Range	R	82	
	Under Range dBm or dB [REL] Mode	S	83	
	Power Sensor Auto Zero Loop Enabled; Range 1 Under Range (normal for auto zeroing on Range 1)	T	84	
	Power Sensor Auto Zero Loop Enabled; Not Range 1, Under Range (normal for auto zeroing on Range 2-5)	U	85	
	Power Sensor Auto Zero Loop Enabled; Over Range (error condition — RF power applied to Power Sensor; should not be)	V	86	
R A N G E	Most Sensitive	1	I	73
		2	J	74
		3	K	75
		4	L	76
	Least Sensitive	5	M	77
M O D E	Watt	A	65	
	dB REL	B	66	
	dB REF (switch pressed)	C	67	
	dBm	D	68	
S I G N	space (+)	SP	32	
	— (minus)	—	45	
D I G I T		0	0	48
		1	1	49
		2	2	50
		3	3	51
		4	4	52
		5	5	53
		6	6	54
		7	7	55
		8	8	56
		9	9	57

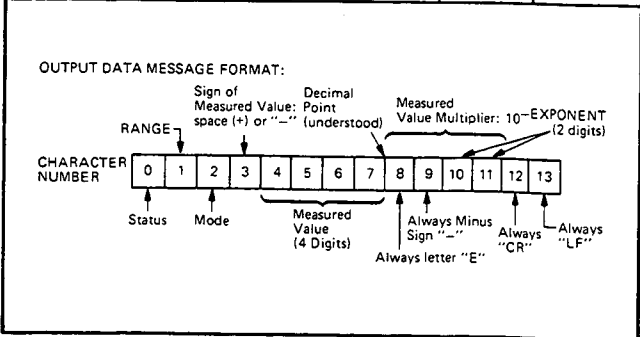



Table 3-5. Power Meter Remote Access Time to First Output Data Character

Measurement Triggering	Mode	Worst Case Access Time to First Output Character																																																		
		Range 1 or 2	Range 3,4 or 5	Auto Range																																																
Free Run at maximum rate, Trigger immediately	WATT	70 ms	70 ms	Compute measurement times from Figure 3-5 and add measurement time of each range that Power Meter steps through to delay time listed below.  <table border="0"> <tr> <td><b>From</b></td><td><b>To</b></td><td><b>Delay</b></td><td><b>From</b></td><td><b>To</b></td><td><b>Delay</b></td> </tr> <tr> <td>1</td><td>2</td><td>1070 ms</td><td>3</td><td>2</td><td>1070 ms</td> </tr> <tr> <td>2</td><td>1</td><td>1070 ms</td><td>4</td><td>3,5</td><td>133 ms</td> </tr> <tr> <td>2</td><td>3</td><td>133 ms</td><td>5</td><td>4</td><td>133 ms</td> </tr> </table> Examples: Starting at block labeled "HOLD" in Figure 3-5, worst case access time for range 1-3, and range 3-1 changes with WATT MODE selected are:  <table border="0"> <tr> <td>Range 1</td><td>70 ms</td><td>Range 3</td><td>50 ms (33+17)</td> </tr> <tr> <td>1-2 Delay</td><td>1070 ms</td><td>3-2 Delay</td><td>1070 ms</td> </tr> <tr> <td>Range 2</td><td>53 ms</td><td>Range 2</td><td>33 ms</td> </tr> <tr> <td>2-3 Delay</td><td>133 ms</td><td>2-1 Delay</td><td>1070 ms</td> </tr> <tr> <td>Range 3</td><td>53 ms</td><td>Range 1</td><td>33 ms</td> </tr> <tr> <td></td><td><u>1379 ms</u></td><td></td><td><u>2256 ms</u></td> </tr> </table>	<b>From</b>	<b>To</b>	<b>Delay</b>	<b>From</b>	<b>To</b>	<b>Delay</b>	1	2	1070 ms	3	2	1070 ms	2	1	1070 ms	4	3,5	133 ms	2	3	133 ms	5	4	133 ms	Range 1	70 ms	Range 3	50 ms (33+17)	1-2 Delay	1070 ms	3-2 Delay	1070 ms	Range 2	53 ms	Range 2	33 ms	2-3 Delay	133 ms	2-1 Delay	1070 ms	Range 3	53 ms	Range 1	33 ms		<u>1379 ms</u>		<u>2256 ms</u>
	<b>From</b>	<b>To</b>	<b>Delay</b>		<b>From</b>	<b>To</b>	<b>Delay</b>																																													
1	2	1070 ms	3	2	1070 ms																																															
2	1	1070 ms	4	3,5	133 ms																																															
2	3	133 ms	5	4	133 ms																																															
Range 1	70 ms	Range 3	50 ms (33+17)																																																	
1-2 Delay	1070 ms	3-2 Delay	1070 ms																																																	
Range 2	53 ms	Range 2	33 ms																																																	
2-3 Delay	133 ms	2-1 Delay	1070 ms																																																	
Range 3	53 ms	Range 1	33 ms																																																	
	<u>1379 ms</u>		<u>2256 ms</u>																																																	
Free Run with settling time or Trigger with settling time.	WATT dBm dB (REL) db [REF]	1130 ms 1130 ms 1200 ms 160 ms	190 ms 190 ms 260 ms 160 ms	Compute worst case Auto Range access times from Figure 3-5.  Examples: Starting at block labeled "HOLD" in Figure 3-5; worst case access times for range 1-3 and range 3-1 with WATT MODE selected are: 1-3 (1070 + 53, +1070 + 53 + 133 + 53) = 2432 ms 3-1 (133+33+ 1070+33 + 1070 + 33) = 2372 ms.																																																

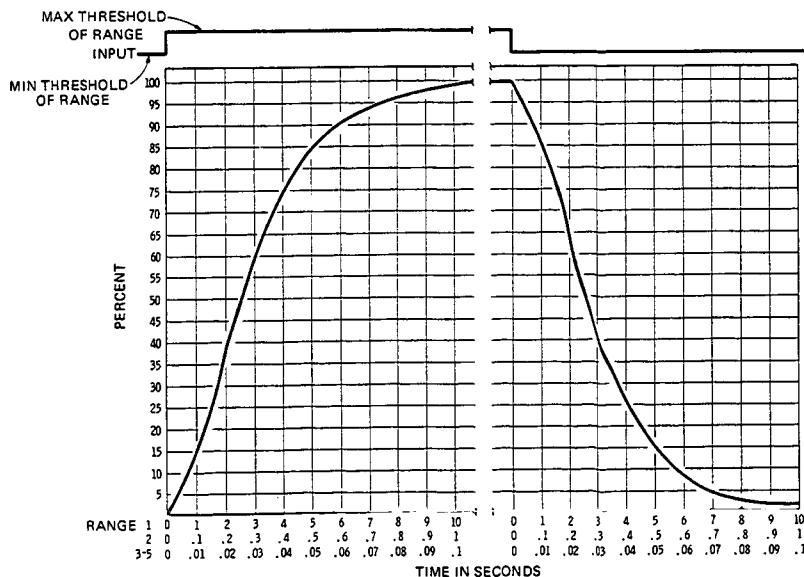

Figure 3-4. Power Meter Response Curve (Settling Time for Analog Circuits)

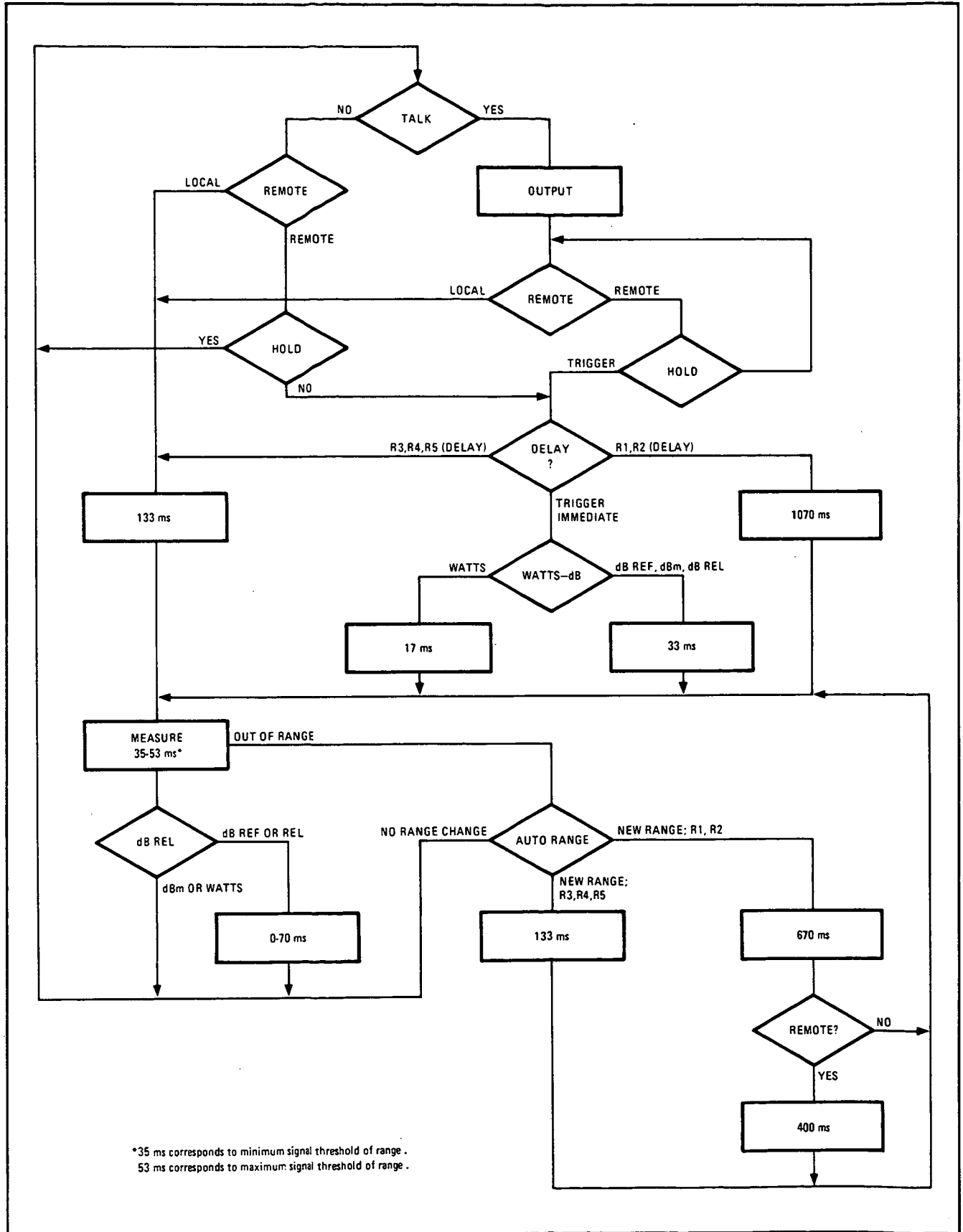
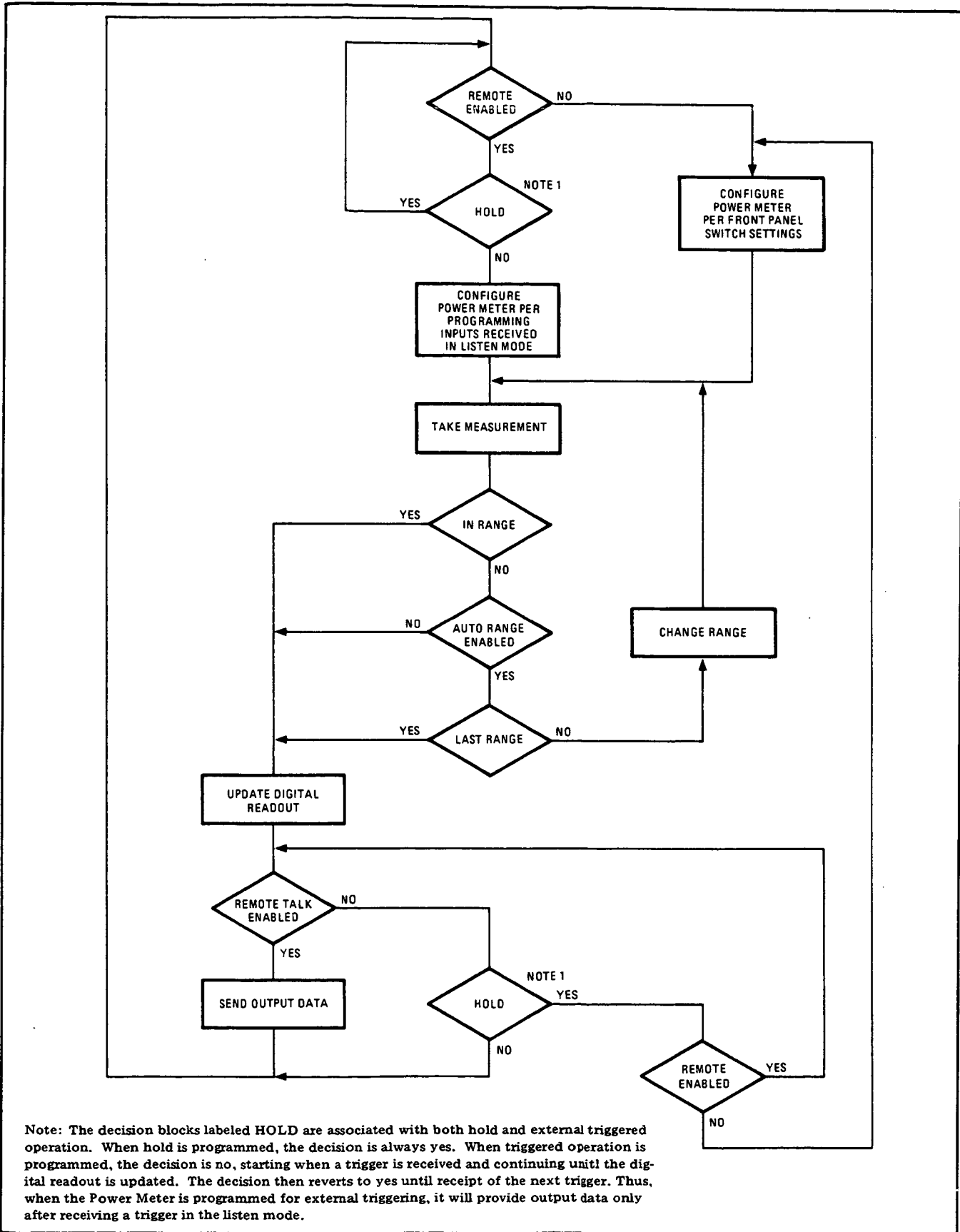

Figure 3-5. Measurement Timing Flow Chart (Setting Time for Digital Circuitry)



Note: The decision blocks labeled HOLD are associated with both hold and external triggered operation. When hold is programmed, the decision is always yes. When triggered operation is programmed, the decision is no, starting when a trigger is received and continuing until the digital readout is updated. The decision then reverts to yes until receipt of the next trigger. Thus, when the Power Meter is programmed for external triggering, it will provide output data only after receiving a trigger in the listen mode.

Figure 3-6. Operating Program Simplified Flow Chart

**Sending Data Messages (cont'd)**

data after taking a measurement. Thus, when the interface bus is placed in the data mode after the Power Meter has been addressed to talk, the time required to access the first output data character depends on where the Power Meter is in the operating program, and on how the Power Meter has been previously programmed (see Programming Codes above.) Worst case access times for each of the Power Meter operating configurations are listed in Table 3-5.

3-39. After the first output character is sent, the remaining characters are sent at either a 10-kHz rate (infinitely fast listener) or at the receive rate of the slowest listener.

**3-40. Receiving the Trigger Message**

3-41. The Power Meter has no provision for responding to a Trigger Message (bus command GET). Power Meter triggering is done with the Data Message (through the Measurement Rate Program Codes).

**3-42. Receiving the Clear Message**

3-43. The Power Meter has provision for responding to the DCL bus command but not the SDC bus command. Upon receipt of the DCL command, the Power Meter operating program is reset causing the Power Meter to enter the Hold state shown at the top of Figure 3-6, and the HP-IB circuits are configured to provide Watt Mode, Auto Range, and Cal Factor Disable outputs.

**3-44. Receiving the Remote Message**

3-45. When the Power Meter receives the Remote Message (REN line low) it completes the rest of its current measurement cycle (see Figure 3-6) and then goes to remote. See the Local to Remote Mode Change (paragraph 3-31) for information about how to program the local to remote mode change.

**3-46. Receiving the Local Message**

3-47. The Power Meter does not respond to the GTL (go to local) bus command. It reverts to local operation when the REN (remote enable) bus line goes false (high).

**3-48. Receiving the Local Lockout and Clear Lockout Set Local Messages**

3-49. The Power Meter does not respond to the Local Lockout Message (LLO bus command). It responds to the Clear Lockout/Set Local Message in that when the REN bus line goes false, it will revert to local operation.

**3-50. Receiving the Pass Control Message**

3-51. The Power Meter has no provision for operation as a controller.

**3-52. Sending the Required Service Message**

3-53. The Power Meter does not have provision for requesting service.

**3-54. Sending the Status Byte Message**

3-55. The Power Meter does not respond to a Serial Poll.

**3-56. Sending the Status Bit Message**

3-57. The Power Meter does not respond to a Parallel Poll.

**3-58. Receiving the Abort Message**

3-59. When the Power Meter receives an Interface Clear command (IFC), it stops talking or listening.

**3-60. Test of HP-IB Operation**

3-61. Figure 3-7 outlines a quick check of the 436A remote functions. This gives the user two alternatives for testing the power meter: 1, write a program corresponding to Figure 3-7 for a quick check or 2, use the program in Section VIII for complete testing and troubleshooting.

**3-62. POWER MEASUREMENT ACCURACY**

3-63. A power measurement is never free from error or uncertainty. Any RF system has RF losses, mismatch losses, mismatch uncertainty, instrumentation uncertainty and calibration uncertainty. Measurement errors as high as 50% are not only possible, they are highly likely unless the error sources are understood and, as much as possible, eliminated.

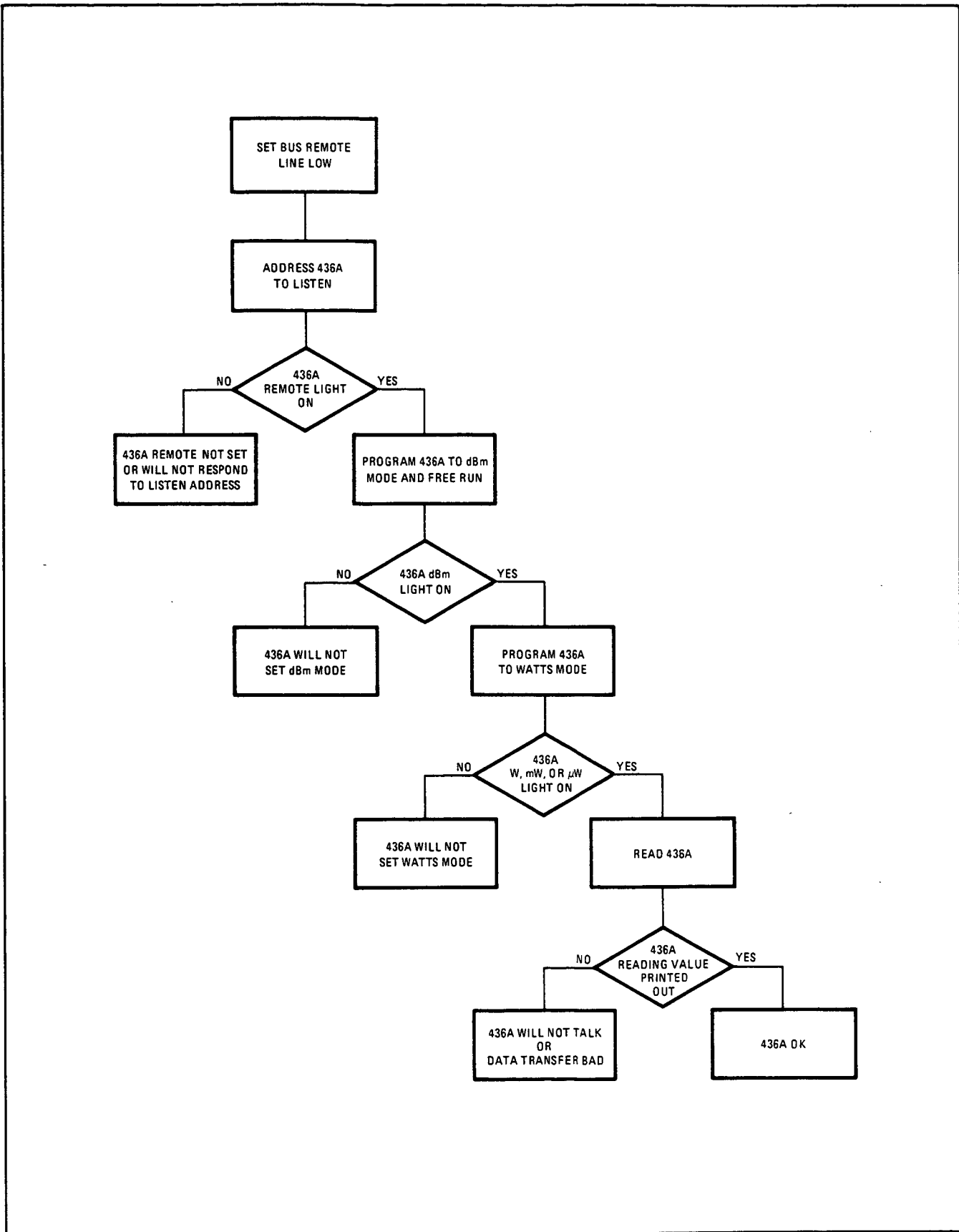
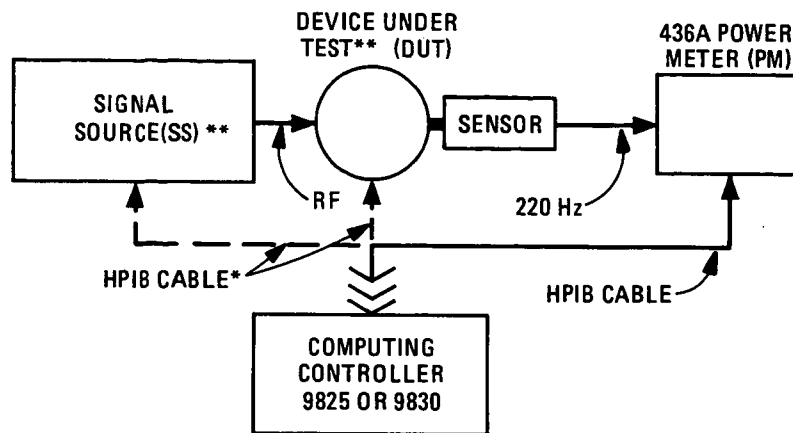

Figure 3-7. Test of HP-IB Operation Flowchart

### 436A QUICK PROGRAMMING GUIDE

This guide will help set up and program simple HP-IB instrumentation systems, thereby freeing you from making an in-depth study of system design and BASIC or HPL programming languages.

#### I. THE SYSTEM:



\* HP-IB cables shown with dotted lines are used only if the Source and Device under test are programmable.

\*\* Signal Source and Device Under Test may be the same, e.g., checking Sig. Gen. Flatness.

II. THE PROGRAM: If the power meter is the only part of the system to be programmed, use the program statements in the order given. For more complex systems or programs, include statements derived from the information in the optional (dashed line) flow chart boxes. When it is necessary to write more statements, refer to Table 3-2.

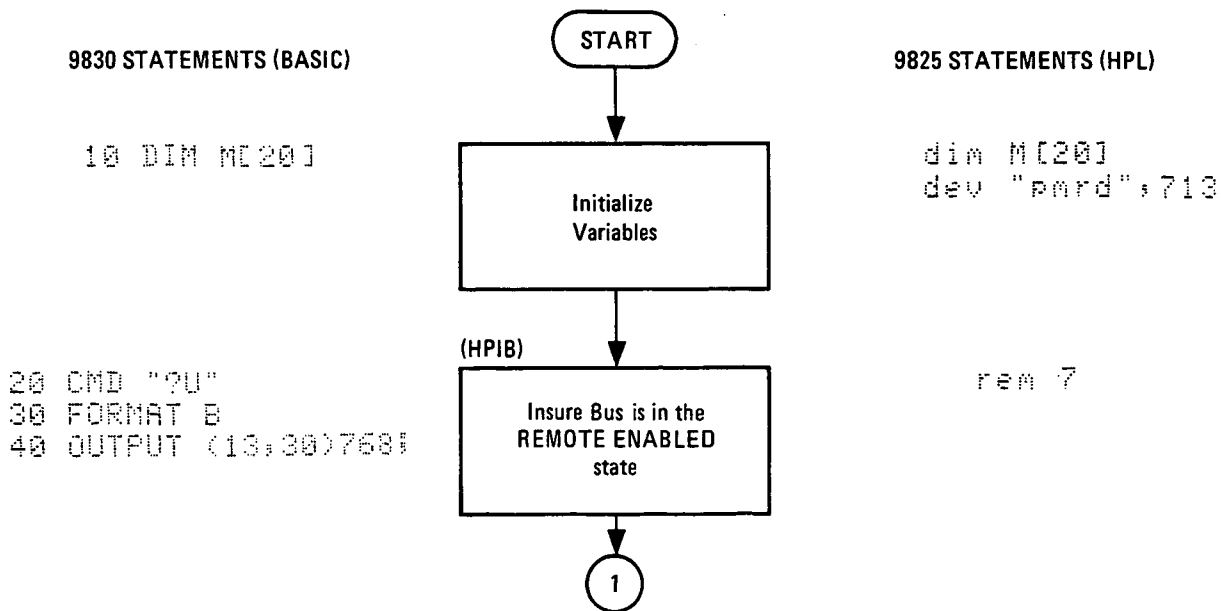

Figure 3-8. 436A Quick Programming Guide (1 of 5)

436A QUICK PROGRAMMING GUIDE (Cont'd)

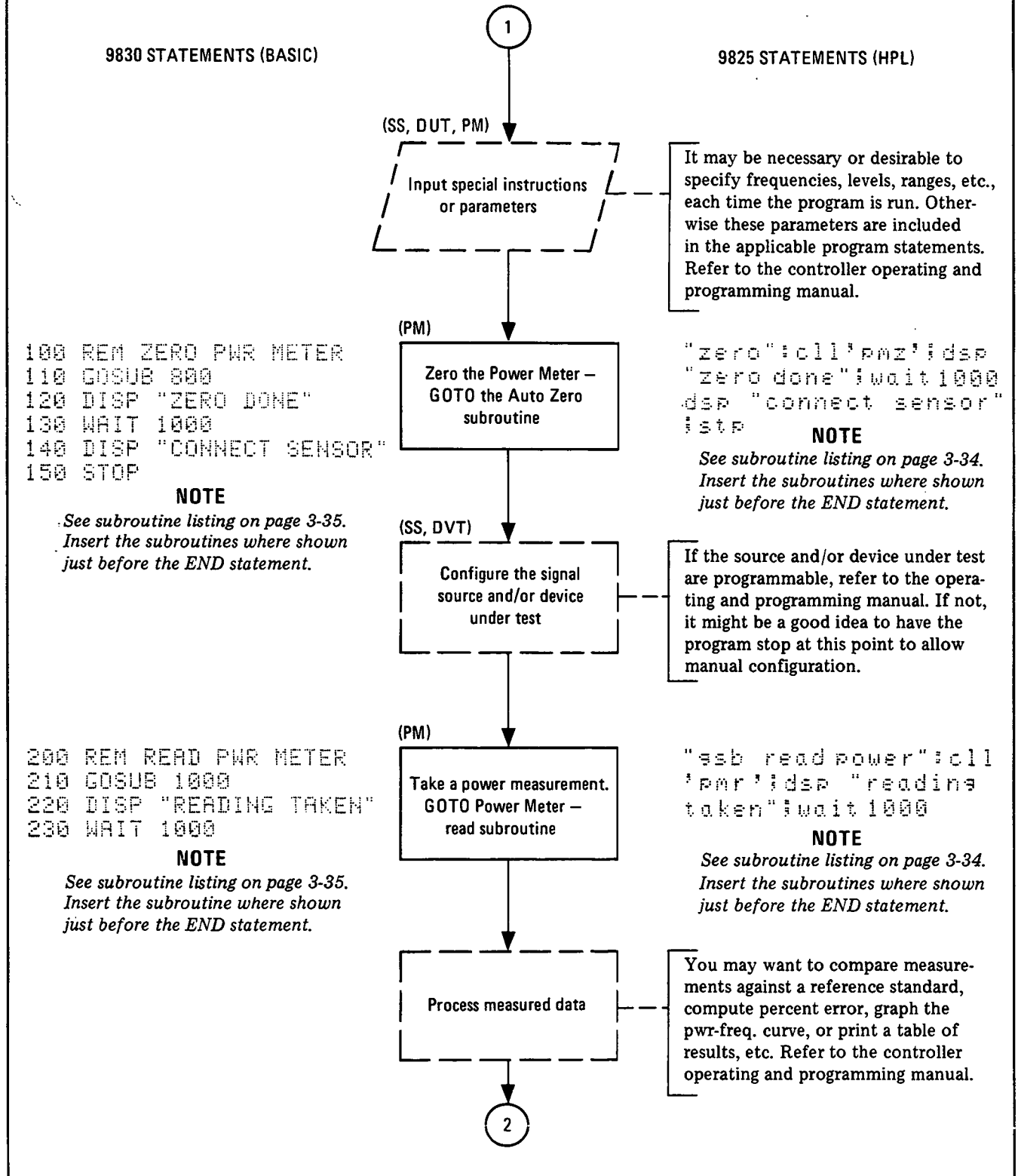
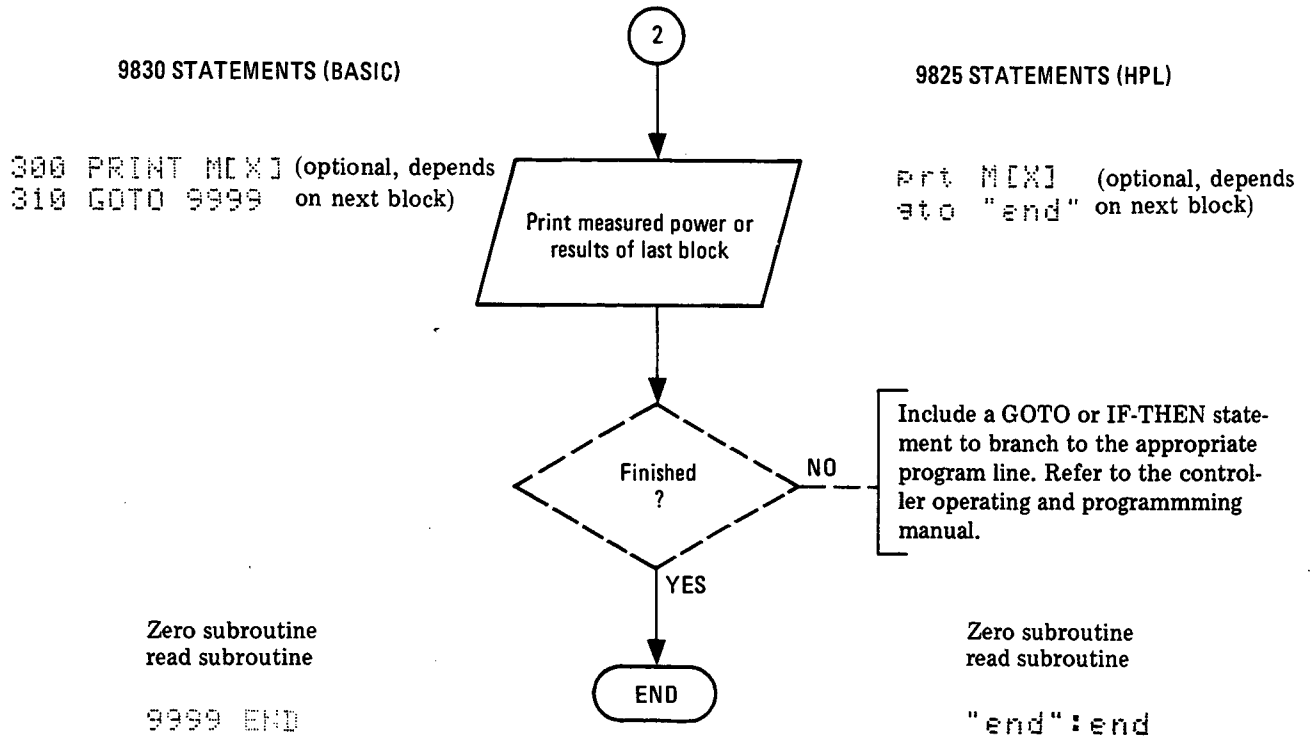

Figure 3-8. 436A Quick Programming Guide (2 of 5)

436A QUICK PROGRAMMING GUIDE (cont'd)



NOTE:

When running the program press CONT-EXECUTE to restart program execution after a STOP (stp) statement.

Figure 3-8. 436A Quick Programming Guide (3 of 5)



## 436A QUICK PROGRAMMING GUIDE (cont'd)

## Subroutines for 9825 (HPL)

## "pmz" – Power meter zero subroutine

```

"pmz":
"remove source":dsp "disconnect sensor from source";stp
wrt "pmrd","Z1T";fmt 2,3x,f5.0;red "pmrd.2",Z
"verify zero":if abs(Z)>2;gto "-1"
"unzero":wrt "pmrd","9+AI";fmt 3,b;red "pmrd.3",Z
"verify unzero": if Z>84;gto "unzero"
"preset/ret":wrt "pmrd","9D+V";ret

```

## "pmr" – Power meter read subroutine

```

"pmr":
fmt 1,1x,b,1x,f5.0,1x,f3.0
0→R
for X=1 to 20
wrt "pmrd", "9D+V"
wait (R=73)4000
red "pmrd.1",R,P,E
if X=1;gto "P1"
if abs(P-S)>1;gto "P1"
P10^E→P;ret
"P1":P→S
next X
dsp "power meter not settled"

```

**Note:** *The next statement should be "end":end, or if another subroutine follows then a gto "end" should be used.*

Figure 3-8. 436A Quick Programming Guide (4 of 5)

### 436A QUICK PROGRAMMING GUIDE (cont'd)

#### Subroutines for 9830 (BASIC)

##### POWER METER ZERO SUBROUTINE

```

800 REM POWER METER ZERO SUBROUTINE
805 DISP "DISCONNECT SENSOR FROM SOURCE"
806 STOP
810 REM ZERO POWER METER
820 CMD "?U-"; "Z1T"
830 FORMAT 3X;F5.0
840 CMD "?M5"
850 ENTER (13;830)Z
860 REM TEST FOR ZERO
870 IF ABS(Z)>2 THEN 810
880 REM UNZERO POWER METER
890 CMD "?U-"; "9+AI"
900 FORMAT 8
910 CMD "?M5"
920 ENTER (13;900)Z
930 REM TEST FOR UNZERO
940 IF Z >= 84 THEN 890
950 REM PRESET POWER METER
960 CMD "?U-"; "9D+V"
970 RETURN

```

##### POWER METER READ SUBROUTINE

```

1000 REM POWER METER READ SUBROUTINE
1010 FORMAT X;B;X;F5.0;X;F3.0
1020 R=0
1030 FOR X=1 TO 20
1040 CMD "?U-"; "9D+V"
1050 WAIT (R=73)*4000
1060 CMD "?M5"
1070 ENTER (13;1010)R;P;E
1080 IF X=1 THEN 1120
1090 IF ABS(P-P1)>1 THEN 1120
1100 P=P*10^(E)
1110 RETURN
1120 P1=P
1130 NEXT X
1140 DISP "POWER METER NOT SETTLED"

```

**Note:** The next statement should be `END`, or if another subroutine follows then a `GOTO 9999` should be used.

### 3-64. Sources of Error and Measurement Uncertainty

**3-65. RF Losses.** Some of the RF power that enters the Power Sensor is not dissipated in the power sensing elements. This RF loss is caused by dissipation in the walls of waveguide power sensors, in the center conductor of coaxial power sensors, in the dielectric of capacitors, connections within the sensor, and radiation losses.

**3-66. Mismatch.** The result of mismatched impedances between the device under test and the power sensor is that some of the power fed to the sensor is reflected before it is dissipated in the load. Mismatches affect the measurement in two ways. First, the initial reflection is a simple loss and is called mismatch loss. Second, the power reflected from the sensor mismatch travels back up the transmission line until it reaches the source. There, most of it is dissipated in the source impedance, but some of it is re-reflected by the source mismatch. The re-reflected power returns to the power sensor and adds to, or subtracts from, the incident power. For all practical purposes, the effect the re-reflected power has upon the power measurement is unpredictable. This effect is called mismatch uncertainty.

**3-67. Instrumentation Uncertainty.** Instrumentation uncertainty describes the ability of the metering circuits to accurately measure the dc output from the Power Sensor's power sensing device. In the Power Meter this error is  $\pm 0.5\%$  for Ranges 1 through 5. It is important to realize, however, that these uncertainty specifications do not indicate overall measurement accuracy.

**3-68. Power Reference Uncertainty.** The output level of the Power Reference Oscillator is factory set to  $1 \text{ mW} \pm 0.70\%$  at 50 MHz. This reference is normally used to calibrate the system, and is, therefore, a part of the system's total measurement uncertainty.

**3-69. Cal Factor Switch Resolution Error.** The resolution of the CAL FACTOR % switch contributes a significant error to the total measurement because the switch has 1% steps. The maximum error possible in each position is  $\pm 0.5\%$ .

### 3-70. Corrections for Error

**3-71.** The two correction factors basic to power meters are calibration factor and effective efficiency. Effective efficiency is the correction

factor for RF losses within the Power Sensor. Calibration factor takes into account the effective efficiency and mismatch losses.

**3-72.** Calibration factor is expressed as a percentage with 100% meaning the power sensor has no losses. Normally the calibration factor will be 100% at 50 MHz, the operating frequency of the internal reference oscillator.

**3-73.** The Power Sensors used with the Power Meter have individually calibrated calibration factor curves placed on their covers. To correct for RF and mismatch losses, simply find the Power Sensor's calibration factor at the measurement frequency from the curve or the table that is supplied with the Power Sensor and set the CAL FACTOR % switch to this value. The measurement error due to this error is now minimized.

**3-74.** The CAL FACTOR % switch resolution error of  $\pm 0.5\%$  may be reduced by one of the following methods:

a. Leave the CAL FACTOR % switch on 100% after calibration, then make the measurement and record the reading. Use the reflection coefficient, magnitude and phase angle from the table supplied with the Power Sensor to calculate the corrected power level.

b. Set the CAL FACTOR % switch to the nearest position above and below the correction factor given on the table. Interpolating between the power levels measured provides the corrected power level.

### 3-75. Calculating Total Uncertainty

**3-76.** Certain errors in calculating the total measurement uncertainty have been ignored in this discussion because they are beyond the scope of this manual. Application Note AN-64, "Microwave Power Measurement", delves deeper into the calculation of power measurement uncertainties. It is available, on request, from your nearest HP office.

**3-77. Known Uncertainties.** The known uncertainties which account for part of the total power measurement uncertainty are:

a. Instrumentation uncertainty  $\pm 0.5\%$  or  $\pm 0.02 \text{ dB}$  (Range 1 through 5).

b. Power reference uncertainty  $\pm 0.7\%$  or  $\pm 0.03 \text{ dB}$ .

**3-77. Known Uncertainties (cont'd)**

c. CAL FACTOR switch resolution  $\pm 0.5\%$  or  $\pm 0.02$  dB.

The total uncertainty from these sources is  $\pm 1.7\%$  or  $\pm 0.07$  dB.

**3-78 Calculating Mismatch Uncertainty.** Mismatch uncertainty is the result of the source mismatch interacting with the Power Sensor mismatch. The magnitude of uncertainty is related to the magnitudes of the source and Power Sensor reflection coefficients, which can be calculated from SWR. Figure 3-9 shows how the calculations are to be made and Figure 3-10 illustrates mismatch uncertainty and total calculated uncertainty for two cases. In the first case, the Power Sensor's SWR =

1.5, and in the second case, the Power Sensor's SWR = 1.26. In both cases the source has a SWR of 2.0. The example shows the effect on power measurement accuracy a poorly matched power sensor will have as compared to one with low mismatch.

**3-79.** A faster, easier way to find mismatch uncertainty is to use the HP Mismatch Error (uncertainty) Limits/Reflectometer Calculator. The calculator may be obtained, on request, from your nearest Hewlett-Packard office by using HP Part Number 5952-0448.

**3-80.** The method of calculating measurement uncertainty from the uncertainty in dB is shown by Figure 3-11. This method would be used when the initial uncertainty calculations were made with the Mismatch Error/Reflectometer Calculator.

### CALCULATING MEASUREMENT UNCERTAINTY

1. Calculate the reflection coefficient from the given SWR.

$$\rho = \frac{\text{SWR} - 1}{\text{SWR} + 1}$$

Power Sensor #1

$$\begin{aligned} \rho_1 &= \frac{1.5 - 1}{1.5 + 1} \\ &= \frac{0.5}{2.5} \\ &= 0.2 \end{aligned}$$

Power Sensor #2

$$\begin{aligned} \rho_2 &= \frac{1.25 - 1}{1.25 + 1} \\ &= \frac{0.25}{2.25} \\ &= 0.111 \end{aligned}$$

Power Source

$$\begin{aligned} \rho_s &= \frac{2.0 - 1}{2.0 + 1} \\ &= \frac{1.0}{3.0} \\ &= 0.333 \end{aligned}$$

2. Calculate the relative power and percentage power mismatch uncertainties from the reflection coefficients. An initial reference level of 1 is assumed.

#### Relative Power Uncertainty

$$\text{PU} = [1 \pm (\rho_n \rho_s)]^2 \text{ where } \begin{matrix} P_n = \text{SWR of Power Sensor \# n} \\ P_s = \text{SWR of Power Source} \end{matrix}$$

$$\begin{aligned} \text{PU}_1 &= \{1 \pm [(0.2)(0.333)]\}^2 \\ &= \{1 \pm 0.067\}^2 \\ &= \{1.067\}^2 \text{ and } \{0.933\}^2 \\ &= 1.138 \text{ and } 0.870 \end{aligned}$$

$$\begin{aligned} \text{PU}_2 &= \{1 \pm [(0.111)(0.333)]\}^2 \\ &= \{1 \pm 0.037\}^2 \\ &= \{1.037\}^2 \text{ and } \{0.963\}^2 \\ &= 1.073 \text{ and } 0.938 \end{aligned}$$

#### Percentage Power Uncertainty

$\% \text{PU} = (\text{PU} - 1) 100\% \text{ for } \text{PU} > 1$	and	$-(1 - \text{PU}) 100\% \text{ for } \text{PU} < 1$
$\% \text{PU}_1 = (1.138 - 1) 100\%$	and	$-(1 - 0.870) 100\%$
$= (0.138) 100\%$	and	$-(0.130) 100\%$
$= 13.8\%$	and	$-13.0\%$
$\% \text{PU}_2 = (1.073 - 1) 100\%$	and	$-(1 - 0.928) 100\%$
$= (0.073) 100\%$	and	$-(0.072) 100\%$
$= 7.3\%$	and	$-7.2\%$

Figure 3-9. Calculating Measurement Uncertainties (1 of 2)

### CALCULATING MEASUREMENT UNCERTAINTY

3. Calculate the Measurement Uncertainty in dB.

$$MU = 10 \left[ \log_{10} \left( \frac{P_1}{P_0} \right) \right] \text{ dB for } \frac{P_1}{P_0} > 1$$

$$= 10 \left[ \log \left( \frac{10P_1}{10P_0} \right) \right] \text{ dB}$$

$$= 10 [\log (10P_1) - \log (10P_0)] \text{ dB for } \frac{P_1}{P_0} < 1$$

$MU_1 = 10 \left[ \log \left( \frac{1.138}{1} \right) \right]$	and	$10 [\log (10) (0.870) - \log (10) (1)]$
$= 10 [0.056]$	and	$10 [\log (8.70) - \log (10)]$
	and	$10 [0.94 - 1]$
	and	$10 [-0.060]$
$= +0.56 \text{ dB}$	and	$-0.60 \text{ dB}$
$MU_2 = 10 \left[ \log \left( \frac{1.073}{1} \right) \right]$	and	$10 [\log (10) (0.928) - \log (10) (1)]$
$= 10 [0.031]$	and	$10 [\log (9.28) - \log (10)]$
	and	$10 [0.968 - 1]$
	and	$10 [-0.032]$
$= +0.31 \text{ dB}$	and	$-0.32 \text{ dB}$

Figure 3-9. Calculating Measurement Uncertainties (2 of 2)

**POWER SENSOR MISMATCH VERSUS MEASUREMENT ACCURACY  
(50 OHM SYSTEM)**

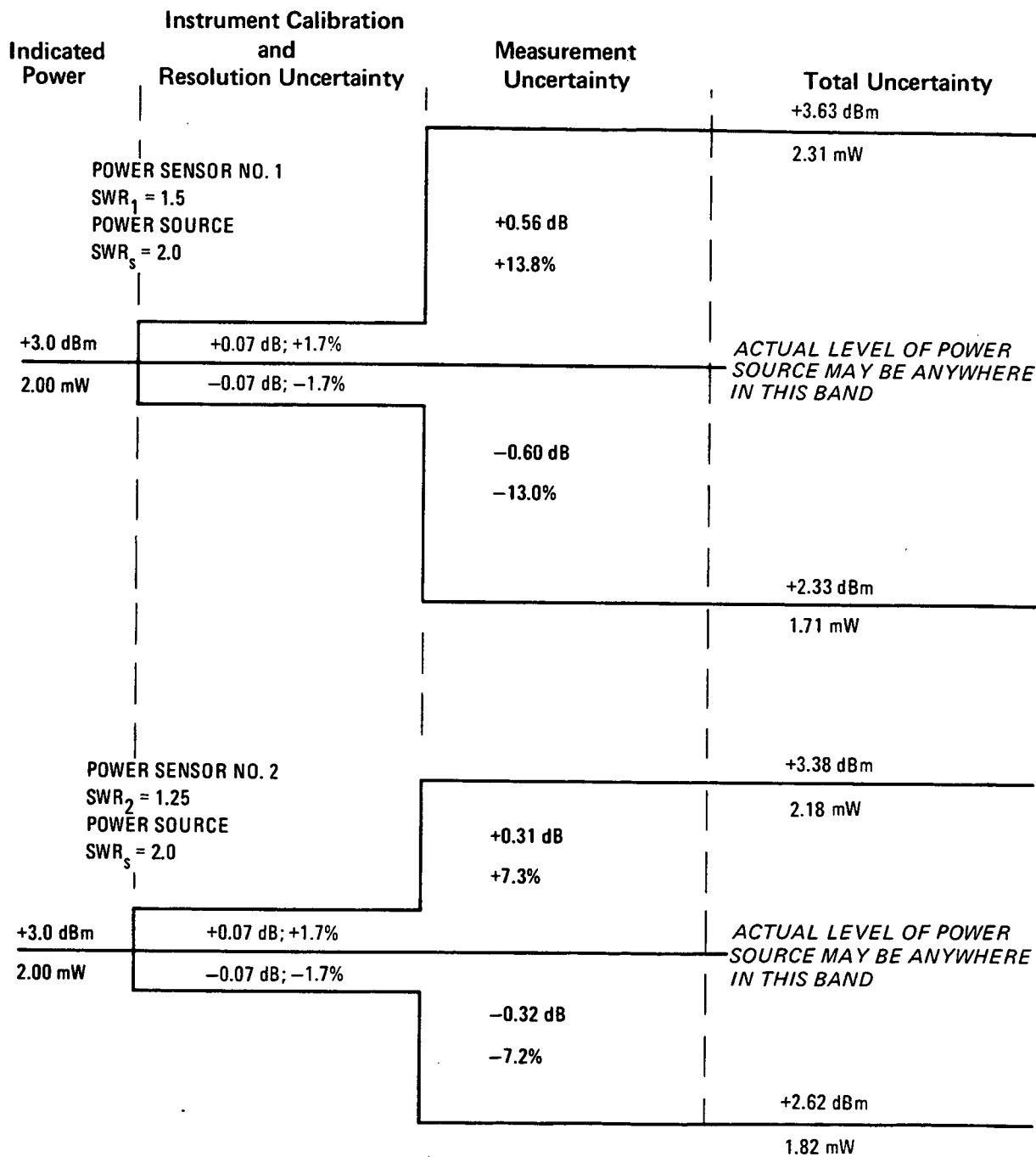

Figure 3-10. The Effect of Power Sensor Mismatch on Measurement Accuracy

**CALCULATING MEASUREMENT UNCERTAINTY**

1. For this example the known values are: source SWR, 2.2 and power sensor SWR, 1.16. From the Mismatch Error Calculator the mismatch uncertainty is found to be +0.24, -0.25 dB.
2. Add the known uncertainties from paragraph 3-73, (± 0.10 dB). Our total measurement uncertainty is +0.34, -0.35 dB.
3. Calculate the relative measurement uncertainty from the following formula:

$$dB = 10 \log \left( \frac{P_1}{P_0} \right)$$

$$\frac{dB}{10} = \log \left( \frac{P_1}{P_0} \right)$$

$$\frac{P_1}{P_0} = \log^{-1} \left( \frac{dB}{10} \right)$$

If dB is positive then:  
 $P_1 > P_0$ ; let  $P_0 = 1$

$$MU = P_1 = \log^{-1} \left( \frac{dB}{10} \right)$$

$$= \log^{-1} \left( \frac{0.34}{10} \right)$$

$$= 1.081$$

If dB is negative then:  
 $P_1 < P_0$ ; let  $P_1 = 1$

$$MU = P_0 = \frac{1}{\log^{-1} \left( \frac{dB}{10} \right)}$$

$$= \frac{1}{\log^{-1} \left( \frac{0.35}{10} \right)}$$

$$= \frac{1}{1.082}$$

$$= 0.923$$

4. Calculate the percentage Measurement Uncertainty.

For  $P_1 > P_0$

$$\%MU = (P_1 - P_0) 100$$

$$= (1.081 - 1) 100$$

$$= +8.1\%$$

For  $P_1 < P_0$

$$\%MU = -(P_1 - P_0) 100$$

$$= -(1 - 0.923) 100$$

$$= -7.7\%$$

Figure 3-11. Calculating Measurement Uncertainty (Uncertainty in dB Known)



## SECTION IV PERFORMANCE TESTS

### 4-1. INTRODUCTION

4-2. The procedures in this section test the electrical performance of the Power Meter using the specifications of Table 1-1 as performance standards. All tests can be performed without access to the interior of the instrument. A simpler operational test is included in Section III under Operator's Checks.

### 4-3. EQUIPMENT REQUIRED

4-4. Equipment required for the performance tests is listed in Table 1-2, Recommended Test Equipment. Any equipment that satisfies the critical specifications given in the table may be substituted for the recommended model(s).

### 4-5. TEST RECORD

4-6. Results of the performance tests may be tabulated on the Test Record at the end of the test procedures. The Test Record lists all of the tested specifications and their acceptable limits. Test results recorded at incoming inspection can be used for comparison in periodic maintenance, troubleshooting, and after repairs or adjustments.

### 4-7. PERFORMANCE TESTS

4-8. The performance tests given in this section are suitable for incoming inspection, troubleshooting, or preventive maintenance. During any performance test, all shields and connecting hardware must be in place. The tests are designed to verify published instrument specifications. Perform the tests in the order given and record the data on the test card and/or in the data spaces provided at the end of each procedure.

#### NOTE

*The Power Meter must have a half-hour warmup and the line voltage must be within +5%, -10% of nominal if the performance tests are to be considered valid.*

4-9. Each test is arranged so that the specification is written as it appears in Table 1-1. Next, a description of the test and any special instructions or problem areas are included. Each test that requires test equipment has a setup drawing and a list of the required equipment. The initial steps of each procedure give control settings required for that particular test.

PERFORMANCE TESTS

4-10. ZERO CARRYOVER TEST

SPECIFICATION:  $\pm 0.2\%$  of full scale when zeroed on the most sensitive range.

DESCRIPTION: After the Power Meter is initially zeroed on the most sensitive range, the change in the digital readout is monitored as the Power Meter is stepped through its ranges. Thus, this test also takes noise and drift into account because noise, drift, and zero carry-over readings cannot be separated.

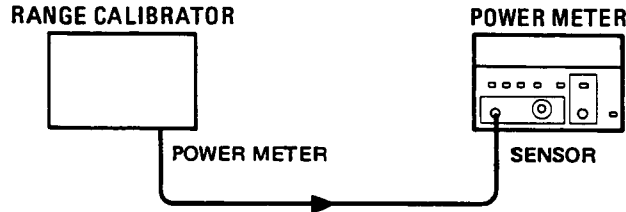

Figure 4-1. Zero Carryover Test Setup

EQUIPMENT: Range Calibrator . . . . . HP 11683A

PROCEDURE:

1. Set the Power Meter switches as follows:
  - CAL FACTOR % . . . . . 100
  - POWER REF . . . . . off (out)
  - MODE . . . . . WATT
  - RANGE HOLD . . . . . off (out)
  - LINE . . . . . ON (in)
2. Set the Range Calibrator switches as follows:
  - FUNCTION . . . . . STANDBY
  - POLARITY . . . . . NORMAL
  - RANGE . . . . . 100  $\mu$ W
  - LINE . . . . . ON (in)

**NOTE:** After switching to STANDBY, allow 60 seconds for the Range Calibrator to settle before zeroing the Power Meter.

3. Connect the equipment as shown in Figure 4-1.
4. Press and hold the Power Meter SENSOR ZERO switch and wait for the digital readout to stabilize. Then verify that the Power Meter ZERO lamp is lit and that the digital readout indicates  $0.00 \pm 0.02$ .

**NOTE:** Power Meter is now zeroed on most sensitive range (10  $\mu$ W).

5. Release the Power Meter SENSOR ZERO switch and wait for the ZERO lamp to go out before proceeding to the next step.
6. Set the Range Calibrator FUNCTION switch to CALIBRATE and verify that the Power Meter autoranges to the 100  $\mu$ W range.
7. Set the Power Meter RANGE HOLD switch to on (in) and the Range Calibrator FUNCTION switch to standby.

**PERFORMANCE TESTS**

**4-10. ZERO CARRYOVER TEST (cont'd)**

8. Wait for the Power Meter's digital readout to stabilize and verify that the indication observed is within the limits shown on the table below. Then set the POWER Meter RANGE HOLD switch to off (out).
9. Repeat steps 6, 7, and 8 with the Range Calibrator RANGE switch set, in turn, to 1 mW, 10 mW, and 100 mW. Verify that the Power Meter autoranges properly, and that the indication observed on each range is within the limits shown in Table 4-1.

**Table 4-1. Zero Carryover Autorange Digital Readout Results**

Range Calibrator and Power Meter Range	Results		
	Min	Actual	Max
100 $\mu$ W	-0.2	_____	0.2
1 mW	-.002	_____	.002
10 mW	-0.02	_____	0.02
100 mW	-0.2	_____	0.2

**4-11. INSTRUMENT ACCURACY TEST**

SPECIFICATION: WATT MODE:  $\pm 0.5\%$  in Ranges 1 through 5.  
 dBm MODE:  $\pm 0.02$  dB  $\pm 0.001$  dB/ $^{\circ}$ C in Ranges 1 through 5.  
 dB (REL) MODE:  $\pm 0.02$  dB  $\pm 0.001$  dB/ $^{\circ}$ C in Ranges 1 through 5.

**NOTE**

*The dB (REL) specifications are for within-range measurements. For range-to-range accuracy, add the uncertainty associated with the range in which the reference was entered, to the uncertainty associated with the range in which the measurement was made. For example, if a reference is entered in Range 1 and a measurement is made in Range 5, the total uncertainty is  $\pm 0.04$  (Range 1  $\pm 0.02$  + Range 5  $\pm 0.02$  =  $\pm 0.04$ ).*

DESCRIPTION: After the Power Meter is initially calibrated on the 1 mW range, the digital readout is monitored as the Range Calibrator is adjusted to provide reference inputs corresponding to each of the Power Meter operating ranges.

## PERFORMANCE TESTS

## 4-11. INSTRUMENT ACCURACY TEST (cont'd)

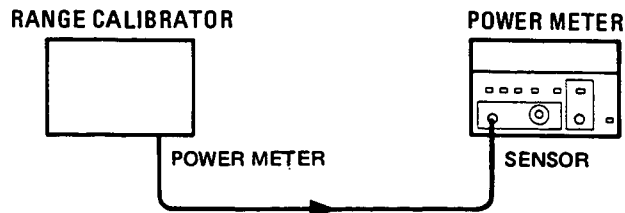

Figure 4-2. Instrument Accuracy Test Setup

EQUIPMENT: Range Calibrator . . . . . HP 11683A

- PROCEDURE:
- Set the Power Meter switches as follows:
 

CAL FACTOR % . . . . .	100
POWER REF . . . . .	off (out)
MODE . . . . .	WATT
RANGE HOLD . . . . .	off (out)
LINE . . . . .	ON (in)
  - Set the Range Calibrator switches as follows:
 

FUNCTION . . . . .	STANDBY
POLARITY . . . . .	NORMAL
RANGE . . . . .	1 mW
LINE . . . . .	ON (in)

**NOTE:** After switching to *STANDBY*, allow 60 seconds for the Range Calibrator to settle before zeroing the Power Meter.

- Connect the equipment as shown in Figure 4-2.
- Press and hold the Power Meter SENSOR ZERO switch and wait for the digital readout to stabilize. Then verify that the Power Meter ZERO lamp is lit and that the digital readout indicates  $0.00 \pm 0.02$ . If the digital readout does not indicate  $0.00 \pm 0.02$  repeat the procedure.
 

**NOTE:** Power Meter is now zeroed on the most sensitive range ( $10 \mu\text{W}$ ).
- Release the Power Meter SENSOR ZERO switch and wait for the ZERO lamp to go out before proceeding to the next step.
- Set the Range Calibrator FUNCTION switch to CALIBRATE and verify that the Power Meter autoranges to the 1 mW range.
- Observe the Power Meter digital readout and, if necessary, adjust the front-panel CAL ADJ control to obtain a  $1.000 \pm 0.002$  indication.

**NOTE:** The Range Calibrator output level is adjustable in 5 dB increments. Thus, the  $3 \mu\text{W}$ ,  $30 \mu\text{W}$ ,  $300 \mu\text{W}$ ,  $3 \text{mW}$ , and  $30 \text{mW}$  legends on the RANGE switch are approximations. The true outputs for these settings are  $3.16 \mu\text{W}$ ,  $31.6 \mu\text{W}$ ,  $316 \mu\text{W}$ ,  $3.16 \text{mW}$  and  $31.6 \text{mW}$ .

PERFORMANCE TESTS

4-11. INSTRUMENT ACCURACY TEST (cont'd)

8. Set the Range Calibrator RANGE switch to the lowest setting (3  $\mu$ W) and wait a few seconds for the meter to settle.
9. Set the Range Calibrator RANGE switch to 10  $\mu$ W (-20 dBm).
10. When the power meter reading has settled, verify that the reading is within the limits specified in the WATT mode in Table 4-2.
11. Set the power meter MODE switch to dBm. Verify that the reading is within limits specified for dBm Mode in Table 4-2.
12. Set the MODE switch back to WATT and set the Range Calibrator RANGE switch to the next setting specified in Table 4-2 (100  $\mu$ W). Repeat steps 10 and 11.
13. Repeat steps 10 and 11 at each range setting specified in Table 4-2.

Table 4-2. Instrument Accuracy Test Results (P/O Errata)

Range Calibrator and Power Meter Range	Results (Watt Mode)			Range Calibrator and Power Meter Range	Results (dBm Mode)		
	Min.	Actual	Max.		Min.	Actual	Max.
10 $\mu$ W	9.95		10.05	-20 dBm	-20.02		-19.98
100 $\mu$ W	99.5		100.5	-10 dBm	-10.02		-9.98
1 mW	0.995		1.005	0 dBm	-0.02		0.02
3 mW	3.14		3.18	+5 dBm	4.98		5.02
10 mW	9.95		10.05	+10 dBm	9.98		10.02
100 mW	99.5		100.5	+20 dBm	19.98		20.02

14. Set the Range Calibrator RANGE switch to -10 dBm.
15. Set the Power Meter MODE switch to dB [REF] and verify that the digital readout indicates  $0.00 \pm 0.01$ .
16. Set the Range Calibrator RANGE switch, in turn, to -20 dBm, -5 dBm, and +10 dBm. Verify that the Power Meter autoranges properly, and that the indication observed on each range is within the limits specified in Table 4-3.

Table 4-3. Instrument Accuracy Test Results for dB [REF] Mode

Range Calibrator and Power Meter Ranges	Results		
	Min	Actual	Max
-20 dBm	-9.96	_____	-10.04
-5 dBm	+4.96	_____	+5.04
+10 dBm	+19.96	_____	20.04

## PERFORMANCE TESTS

## 4-12. CALIBRATION FACTOR TEST

**SPECIFICATION:** 16-position switch normalizes meter reading to account for calibration factor. Range 85% to 100% in 1% steps. 100% position corresponds to calibration factor at 50 MHz.

**DESCRIPTION:** After the Power Meter is zeroed on the most sensitive range, a 1 mW input level is applied to the Power Meter and the CAL ADJ control is adjusted to obtain a 1.000 mW indication. Then the CAL FACTOR % switch is stepped through its 16 positions and the digital readout is monitored to ensure that the proper indication is obtained for each position.

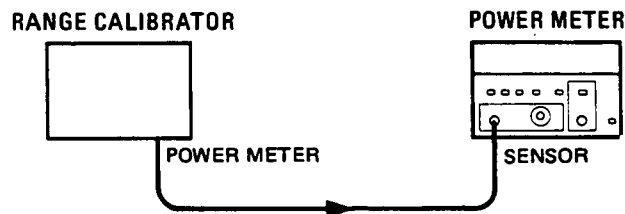

Figure 4-3. Calibration Factor Test Setup

**PROCEDURE:**

1. Set the Power Meter switches as follows:

CAL FACTOR % . . . . . 100  
 POWER REF . . . . . Off (out)  
 MODE . . . . . WATT  
 RANGE HOLD . . . . . Off (out)  
 LINE . . . . . ON (in)

2. Set the Range Calibrator switches as follows:

FUNCTION . . . . . STANDBY  
 POLARITY . . . . . NORMAL  
 RANGE . . . . . 1 mW  
 LINE . . . . . ON (in)

**NOTE:** After switching to STANDBY, allow 60 seconds for the Range Calibrator to settle before zeroing the Power Meter.

3. Connect the equipment as shown in Figure 4-3.
4. Press and hold the Power Meter SENSOR ZERO switch and wait for the digital readout to stabilize. Then verify that the Power Meter ZERO lamp is lit and that the digital readout indicates  $0.00 \pm 0.02$ .

**NOTE:** Power Meter is now zeroed on the most sensitive range ( $10 \mu W$ ).

5. Release the Power Meter SENSOR ZERO switch and wait for the ZERO lamp to go out before proceeding to step 6.
6. Set the Range Calibrator FUNCTION switch to CALIBRATE and verify that the Power Meter autoranges to the 1 mW range.
7. Adjust the Power Meter CAL ADJ control to obtain a  $1.000 \pm 0.002$  indication on the digital readout.

PERFORMANCE TESTS

4-12. CALIBRATION FACTOR TEST (cont'd)

8. Set the CAL FACTOR % switch, in turn, to each position and verify that the indications observed are within the limits specified in Table 4-4.

Table 4-4. Calibration Factor Test Results

CAL FACTOR Switch Position	Results			CAL FACTOR Switch Position	Results		
	Min.	Actual	Max.		Min.	Actual	Max.
100	0.994	_____	1.006	92	1.081	_____	1.093
99	1.004	_____	1.016	91	1.093	_____	1.105
98	1.014	_____	1.026	90	1.105	_____	1.117
97	1.025	_____	1.037	89	1.118	_____	1.130
96	1.036	_____	1.048	88	1.130	_____	1.142
95	1.047	_____	1.059	87	1.143	_____	1.155
94	1.058	_____	1.070	86	1.157	_____	1.169
93	1.069	_____	1.081	85	1.170	_____	1.182

4-13. POWER REFERENCE LEVEL TEST

**SPECIFICATION:** Internal 50 MHz oscillator factory set to 1 mW ± 0.7% traceable to the National Bureau of Standards.  
 Accuracy: ±1.2% worst case (±0.9% rms) for one year (0°C to 55°C).

**DESCRIPTION:** The power reference oscillator output is factory adjusted to 1 mW ± 0.7%. To achieve this accuracy, Hewlett-Packard employs a special measurement system accurate to 0.5% (traceable to the National Bureau of Standards) and allows for a transfer error of ±0.2% in making the adjustment. If an equivalent measurement system is employed for verification, the power reference oscillator output can be verified to 1 mW ± 1.9% (±1.2% accuracy + ±0.5% verification system error + ±0.2% transfer error = 1.9% maximum error). The power reference oscillator can be set to ±0.7% using the same equipment and following the adjustment procedure in paragraph 5-22. To ensure maximum accuracy in verifying the power reference oscillator output, the following procedure provides step-by-step instructions for using specified Hewlett-Packard test instruments of known capability. If equivalent test instruments are used, signal acquisition criteria may vary and reference should be made to the manufacturer's guidelines for operating the instruments.

NOTE

*The Power Meter may be returned to the nearest Hewlett-Packard office to have the power reference oscillator checked and/or adjusted. Refer to Section II, PACKAGING.*

## PERFORMANCE TESTS

## 4-13. POWER REFERENCE LEVEL TEST (cont'd)

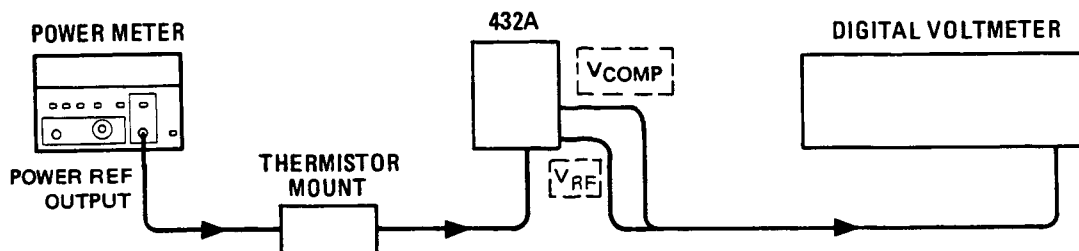

Figure 4-4. Power Reference Level Test Setup

EQUIPMENT: Power Meter . . . . . HP 432A  
 Thermistor Mount . . . . . HP 478A-H75  
 Digital Voltmeter (DVM) . . . . . HP 3456A

- PROCEDURE:
1. Set up the DVM to measure resistance and connect the DVM between the  $V_{RF}$  connector on the rear panel of the 432A, and pin 1 on the thermistor mount end of the 432A interconnect cable.
  2. Round off the DVM indication to two decimal places and record this value as the internal bridge resistance ( $R$ ) of the 432A (approximately 200 ohms).
  3. Connect the 432A to the Power Meter as shown in Figure 4-4.
  4. Set the Power Meter LINE switch to ON (in) and the POWER REF switch to off (out). Then wait thirty minutes for the 432A thermistor mount to stabilize before proceeding to the next step.
  5. Set the 432A RANGE switch to COARSE ZERO and adjust the front-panel COARSE ZERO control to obtain a zero meter indication.
  6. Fine zero the 432A on the most sensitive range, then set the 432A RANGE switch to 1 mW.

## NOTE

*Ensure that DVM input leads are isolated from chassis ground when performing the next step.*

7. Set up the DVM to measure microvolts and connect the positive and negative input leads, respectively, to the  $V_{COMP}$  and  $V_{RF}$  connectors on the rear panel of the 432A.
8. Observe the indication on the DVM. If less than 400 microvolts, proceed to the next step. If 400 microvolts or greater, press and hold the 432A FINE ZERO switch and adjust the COARSE ZERO control so that the DVM indicates 200 microvolts or less. Then release the FINE ZERO switch and proceed to the next step.
9. Round off the DVM indication to the nearest microvolt and record this value as  $V_0$ .



**PERFORMANCE TESTS**

---

**4-13. POWER REFERENCE LEVEL TEST (cont'd)**

10. Set the Power Meter POWER REF switch to ON (in) and record the indications observed on the DVM as  $V_1$ .
11. Disconnect the DVM negative input lead from the  $V_{RF}$  connector on the 432A and reconnect it to 432A chassis ground. Record the new indication observed on the DVM as  $V_{COMP}$ .
12. Calculate the power reference oscillator output level ( $P_{RF}$ ) from the following formula:

$$P_{RF} = \frac{2 V_{COMP} (V_1 - V_0) + V_0^2 - V_1^2}{4R \text{ (CALIBRATION FACTOR)}}$$

Where:

$P_{RF}$  = power reference oscillator output level

$V_{COMP}$  = previously recorded value

$V_1$  = previously recorded value

$V_0$  = previously recorded value

R = previously recorded value

CALIBRATION FACTOR = value for thermistor mount at 50 MHz (traceable to the National Bureau of Standards)

13. Verify that the  $P_{RF}$  is within the following limits:

Min.	Actual	Max.
0.988 mW	_____	1.012 mW

Table 4-5. Performance Test Record (1 of 2)

Hewlett-Packard Company Model 436A Power Meter		Tested By _____		
Serial Number _____		Date _____		
Para. No.	Test	Results		
		Min	Actual	Max
4-10.	<b>ZERO CARRYOVER</b>			
	10 $\mu$ W	-0.02 $\mu$ W	_____	0.02 $\mu$ W
	100 $\mu$ W	-0.2 $\mu$ W	_____	0.2 $\mu$ W
	1 mW	-0.002 mW	_____	0.002 mW
	10 mW	-0.02 mW	_____	0.02 mW
	100 mW	-0.2 mW	_____	0.2 mW
4-11.	<b>INSTRUMENTATION ACCURACY</b>			
	<b>WATT MODE</b>			
	10 $\mu$ W	9.95 $\mu$ W	_____	10.05 $\mu$ W
	100 $\mu$ W	99.5 $\mu$ W	_____	100.5 $\mu$ W
	1 mW	0.995 mW	_____	1.005 mW
	10 mW	9.95 mW	_____	10.05 mW
	100 mW	99.5 mW	_____	100.5 mW
	<b>dBm MODE</b>			
	-20 dBm	-20.02 dBm	_____	-19.98 dBm
	-10 dBm	-10.02 dBm	_____	-9.98 dBm
	0 dBm	-0.02 dBm	_____	0.02 dBm
	10 dBm	9.98 dBm	_____	10.02 dBm
	20 dBm	19.98 dBm	_____	20.02 dBm
	<b>dB (REL) MODE</b>			
	-20 dBm	-9.96 dBm	_____	-10.04 dBm
- 5 dBm	+4.96 dBm	_____	+5.04 dBm	
+10 dBm	+19.96 dBm	_____	20.04 dBm	
4-12.	<b>CALIBRATION FACTOR</b>			
	100	0.994 mW	_____	1.006 mW
	99	1.004 mW	_____	1.016 mW
	98	1.014 mW	_____	1.026 mW
	97	1.025 mW	_____	1.037 mW
	96	1.036 mW	_____	1.048 mW
	95	1.047 mW	_____	1.059 mW
	94	1.058 mW	_____	1.070 mW
93	1.069 mW	_____	1.081 mW	

Table 4-5. Performance Test Record (2 of 2)

Para. No.	Test	Results		
		Min.	Actual	Max
4-12.	<b>CALIBRATION FACTOR (cont'd)</b>			
	92	1.081 mW	_____	1.093 mW
	91	1.093 mW	_____	1.105 mW
	90	1.105 mW	_____	1.117 mW
	89	1.118 mW	_____	1.130 mW
	88	1.130 mW	_____	1.142 mW
	87	1.143 mW	_____	1.155 mW
	86	1.157 mW	_____	1.169 mW
85	1.170 mW	_____	1.182 mW	
4-13	<b>POWER REFERENCE</b> $P_{RF}$	0.988 mW	_____	1.012 mW

## SECTION V ADJUSTMENTS

### 5-1. INTRODUCTION

5-2. This section describes the adjustments which will return the Power Meter to peak operating condition after repairs are completed.

5-3. If the adjustments are to be considered valid, the Power Meter must have a half-hour warmup and the line voltage must be within +5 to -10% of nominal.

### 5-4. SAFETY CONSIDERATIONS

5-5. Although this instrument has been designed in accordance with international safety standards, this manual contains information, cautions, and warnings which must be followed to ensure safe operation and to retain the instrument in safe condition (see Sections II and III). Service and adjustments should be performed only by qualified service personnel.

#### WARNING

*Any interruption of the protective (grounding) conductor (inside or outside the instrument) or disconnection of the protective earth terminal is likely to make the instrument dangerous. Intentional interruption is prohibited.*

5-6. Any adjustment, maintenance, and repair of the opened instrument with voltage applied should be avoided as much as possible and, when inevitable, should be carried out only by a skilled person who is aware of the hazard involved.

5-7. Capacitors inside the instrument may still be charged even if the instrument has been disconnected from its source of supply.

5-8. Make sure that only fuses with the required rated current and of the specified type (normal blow, time delay, etc.) are used for replacement. The use of repaired fuses and the shortcircuiting of fuseholders must be avoided.

5-9. Whenever it is likely that the protection offered by fuses has been impaired, the instrument must be made inoperative and secured against any unintended operation.

#### WARNING

*Adjustments described herein are performed with power supplied to the instrument while protective covers are removed. Energy available at many points may, if contacted, result in personal injury.*

### 5-10. EQUIPMENT REQUIRED

5-11. The test equipment required for the adjustment procedures is listed in Table 1-2, Recommended Test Equipment. The critical specifications of substitute test instruments must meet or exceed the standards listed in the table if the Power Meter is to meet the standards set forth in Table 1-1, Specifications.

### 5-12. FACTORY SELECTED COMPONENTS

5-13. Factory selected components are indicated on the schematic and replaceable parts list with an asterisk immediately following the reference designator. The nominal value of the component is listed. Table 5-1 lists the parts by reference designator and provides an explanation of how the component is selected, the normal value range, and a reference to the appropriate service sheet. The Manual Changes supplement will update any changes to factory selected component information.

### 5-14. ADJUSTMENT LOCATIONS

5-15. Each of the adjustments are shown on the component locator photographs that are part of the Service Sheets.

## ADJUSTMENTS

Table 5-1. Factory Selected Components

Reference Designator	Selected For	Normal Value Range	Service Sheet
A2R7, R12, R18 and R81	Optimum Power Meter accuracy above 10 mW. Measure (to 3 significant digits) the +15 and -15V supply voltages at A9TP3 and TP4. Connect the Range Calibrator HP 11683A to the Power Meter's sensor connector. IF the magnitude of the -15V supply exceeds the magnitude of the +15V supply OR IF the magnitude of the +15V supply does not exceed the magnitude of the -15V supply by more than 0.5 Vdc, THEN select A2R12 for 10.00 to 10.01 mW reading with a 10 mW input. (Increasing A2R12 increases the reading.) With 100 mW input select A2R18 and R81 for a reading of 99.9 to 100.0. (Increasing A2R18 and R81 increases the power meter reading.) Check the 10 mW and 30 mW full scale readings and choose compromise resistor values as necessary for a maximum $\pm 1$ count error. IF the magnitude of the +15V supply exceeds the magnitude of the -15V supply by more than 0.5V THEN change A2R7 to 40.0 k $\Omega$ , and follow the previous selection procedure.	A2R7 42.2 k $\Omega$ (40.0 k $\Omega$ to 42.2 k $\Omega$ ) A2R12 100 k $\Omega$ (20.0 k $\Omega$ to 147 k $\Omega$ ) A2R18 178 k $\Omega$ * A2R81 9.09 k $\Omega$ *	7
A2R50	Adjust A2R69 FREQ (Frequency Adj) for maximum indication on digital readout, then check frequency of 220 MHz Multivibrator. If out of specification (220 $\pm$ 16 Hz) select value for A2R50 to produce maximum indication on digital readout while 220 Hz Multivibrator frequency is in specification.	13.3 k $\Omega$ (10 k $\Omega$ to 17.8 k $\Omega$ )	7
A8R5	A Power Reference Oscillator output of 1 mW if this value falls outside the range of adjustment available with LEVEL ADJUST potentiometer A8R5	7100 $\Omega$ (7100 $\Omega$ to 7500 $\Omega$ )	14
A2VR1,2	Correct accuracy on the 30 mW, and 100 mW ranges when accuracy on the other ranges is within specifications.	2.37V to 2.61V	7
A8VR2, A8R2	1) If the reference output power is outside the range of 1.000 $\pm$ .007 mW between 0 $^{\circ}$ C and 55 $^{\circ}$ C, and 2) if the A8VR2, A8R2 combination is 5.11V-825 $\Omega$ , then change the A8VR2, A8R2 combination to 8.25V-1470 $\Omega$ . However, if the A8VR2, A8R2 combination is already 8.25V-1470 $\Omega$ , then a problem exists elsewhere.	5.11V-825 $\Omega$ or 8.25V-1470 $\Omega$	14
A2C14	Proper phase detector operation with a multivibrator frequency of 220 Hz.	4700 pF (2500 pF to 10,000 pF)	7

NOTE: Do the Power Supply Adjustment (paragraph 5-23) first, then do the adjustments described in paragraphs 5-16 through 5-22.

\*Combined series resistance 147 k $\Omega$  to 500 k $\Omega$ .

ADJUSTMENTS

5-16. DC OFFSET ADJUSTMENT

REFERENCE: Service Sheet 8.

DESCRIPTION: DC OFF potentiometer A3R2 is adjusted to remove any dc voltage introduced by the dc amplifier

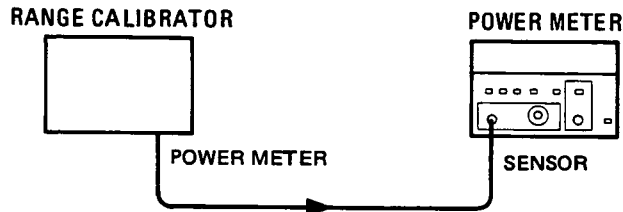

Figure 5-1. DC Offset Adjustment Setup

EQUIPMENT: Range Calibrator . . . . . HP 11683A

- PROCEDURE:
1. Set the Power Meter Switches as follows:
    - CAL FACTOR % . . . . . 100
    - POWER REF . . . . . off (out)
    - MODE . . . . . WATT
    - RANGE HOLD . . . . . off (out)
    - LINE . . . . . ON (in)
  2. Set the Range Calibrator switches as follows:
    - FUNCTION . . . . . CALIBRATE
    - POLARITY . . . . . NORMAL
    - RANGE . . . . . 100 mW
    - LINE . . . . . ON (in)
  3. Connect the equipment as shown in Figure 5-1.
  4. Verify that the Power Meter autoranges to the 100 mW range, then set the RANGE HOLD switch to ON (in).
  5. Set the Range Calibrator FUNCTION switch to STANDBY.
  6. Remove the Power Meter top cover and adjust DC OFF potentiometer A3R2 so that the digital readout indicates 00.0 with a blinking minus sign.

5-17. AUTO ZERO OFFSET ADJUSTMENT

REFERENCE: Service Sheet 8.

DESCRIPTION: ZERO OFF potentiometer A3R47 is adjusted to remove any dc offset that is introduced when the SENSOR ZERO switch is pressed.

## ADJUSTMENTS

## 5-17. AUTO ZERO OFFSET ADJUSTMENT (cont 'd)

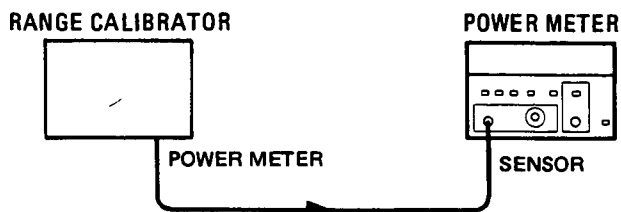

Figure 5-2. Auto Zero Offset Adjustment Setup

EQUIPMENT: Range Calibrator . . . . . HP 11683A

PROCEDURE: 1. Set the Power Meter switches as follows:

CAL FACTOR % . . . . . 100  
 POWER REF . . . . . off (out)  
 MODE . . . . . WATT  
 RANGE HOLD . . . . . off (out)  
 LINE . . . . . ON (in)

2. Set the Range Calibrator switches as follows:

FUNCTION . . . . . STANDBY  
 POLARITY . . . . . NORMAL  
 LINE . . . . . ON (in)

3. Connect the equipment as shown in Figure 5-2.

4. Verify that the Power Meter autoranges to the 10  $\mu$ W range, and remove the Power Meter top cover.

## NOTE

*If specified indication cannot be obtained in next step, perform DC Spike Balance Adjustment. Then repeat this procedure.*

5. Press and hold the Power Meter SENSOR ZERO switch and adjust ZERO OFF potentiometer A3R47 so that the digital readout indicates 0.00 with blinking minus sign.

## 5-18. SPIKE BALANCE ADJUSTMENT

REFERENCE: Service Sheets 7 and 8.

DESCRIPTION: A reference signal is applied to the Power Meter from the Range Calibrator to force the sensor zero circuit to its negative extreme. The SENSOR ZERO switch is then held pressed while BAL potentiometer A3R65 is adjusted to center the sensor zero circuit output voltage range.

ADJUSTMENTS

5-18. SPIKE BALANCE ADJUSTMENT (cont'd)

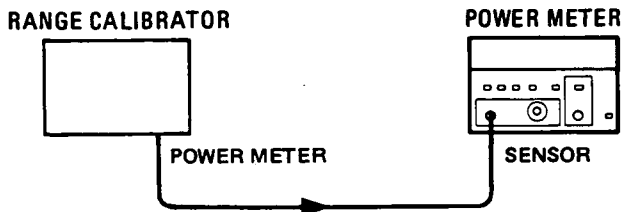

Figure 5-3. Spike Balance Adjustment Setup

EQUIPMENT: Range Calibrator . . . . . HP 11683A

PROCEDURE: 1. Set the Power Meter switches as follows:

- CAL FACTOR % . . . . . 100
- POWER REF . . . . . off (out)
- MODE . . . . . WATT
- RANGE HOLD . . . . . off (out)
- LINE . . . . . ON (in)

2. Set the Range Calibrator switches as follows:

- FUNCTION . . . . . CALIBRATE
- POLARITY . . . . . NORMAL
- RANGE . . . . . 100  $\mu$ W
- LINE . . . . . ON (in)

3. Remove the Power Meter top cover and adjust the front-panel CAL ADJ control so that the digital readout indicates 100.0  $\mu$ W

4. Press and hold the Power Meter SENSOR ZERO switch and adjust BAL potentiometer A3R65 so that the display readout indicates 60.0  $\pm$  0.2  $\mu$ W.

NOTE

*The Power Meter sensor zero circuit must be re-zeroed as described in the following steps before valid power measurements can be made.*

5. Set the Range Calibrator FUNCTION switch to standby. Then press the Power Meter SENSOR ZERO switch and wait for the digital readout to stabilize.

6. Release the Power Meter SENSOR ZERO switch and wait for the ZERO lamp to go out.



## ADJUSTMENTS

## 5-19. MULTIVIBRATOR ADJUSTMENT

REFERENCE: Service Sheet 7.

DESCRIPTION: FREQ potentiometer A2R69 is adjusted to set the reference frequency of the multivibrator which drives the phase detector and the FET power sensor.

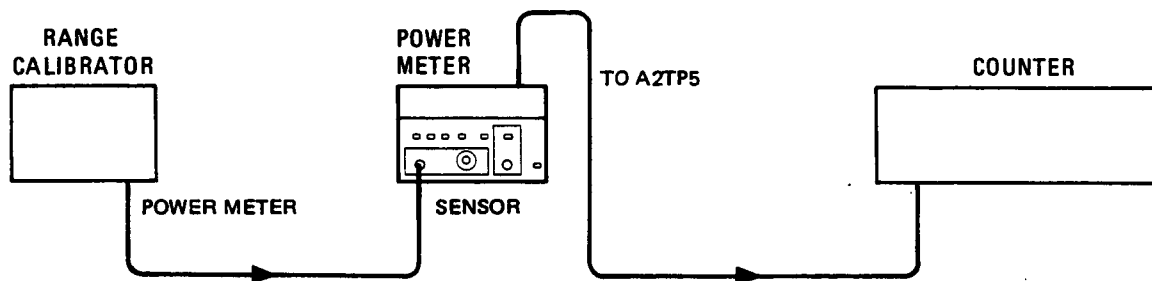

Figure 5-4. Multivibrator Adjustment Setup

EQUIPMENT: Range Calibrator . . . . . HP 11683A  
Counter . . . . . HP 5315A

- PROCEDURE:
- Set the Power Meter switches as follows:
 

CAL FACTOR % . . . . .	100
POWER REF . . . . .	off (out)
MODE . . . . .	WATT
RANGE HOLD . . . . .	off (out)
LINE . . . . .	ON (in)
  - Set the Range Calibrator switches as follows:
 

FUNCTION . . . . .	CALIBRATE
POLARITY . . . . .	NORMAL
LINE . . . . .	ON (in)
  - Connect the equipment as shown in Figure 5-4.
  - Remove the Power Meter top cover, adjust FREQ potentiometer A2R69 to obtain maximum indication on the digital readout, and verify that the counter indicates  $220 \pm 16$  Hz.
  - Perform the Instrument Accuracy Test described in Section IV to verify overall Power Meter accuracy. If all indications are obtained as specified, the adjustment is complete. If any indication cannot be obtained as specified, perform the A-D Converter and Linear Meter Adjustment.

ADJUSTMENTS

5-20. A-D CONVERTER AND LINEAR METER ADJUSTMENT

REFERENCE: Service Sheets 7 and 8.

DESCRIPTION: The A-D converter circuit is adjusted to obtain the specified digital readout accuracy and the meter circuit is adjusted for a corresponding indication.

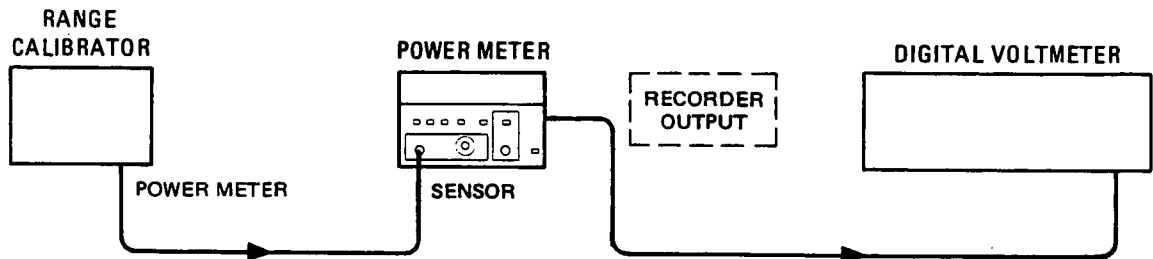

Figure 5-5. A-D Converter and Linear Meter Adjustment Setup

EQUIPMENT: Range Calibrator . . . . . HP 11683A  
 Digital Voltmeter (DVM) . . . . . HP 3456A

- PROCEDURE:
1. Set the Power Meter switches as follows:
    - CAL FACTOR % . . . . . 100
    - POWER REF . . . . . off (out)
    - MODE . . . . . WATT
    - RANGE HOLD . . . . . off (out)
    - LINE . . . . . ON (in)
  2. Set the Range Calibrator switches as follows:
    - FUNCTION . . . . . STANDBY
    - RANGE . . . . . 1 mW
    - POLARITY . . . . . NORMAL
    - LINE . . . . . ON (in)
  3. Connect the equipment as shown in Figure 5-5.
  4. Remove the Power Meter top cover and set the DVM to the 1000 mV range.
  5. Press the Power Meter SENSOR ZERO switch and wait for the display readout to stabilize. Then release the SENSOR ZERO switch and wait for ZERO led to go out before proceeding to the next step.
  6. Set the Range Calibrator FUNCTION switch to CALIBRATE and adjust the Power Meter front-panel CAL ADJ control to obtain a 1.000 Vdc indication on the DVM.
  7. Adjust the Power Meter LIN potentiometer A3R37 so that the digital readout indicates 1.000 mW.

## ADJUSTMENTS

## 5-20. A-D CONVERTER AND LINEAR METER ADJUSTMENT (cont'd)

8. Set the Power Meter MODE and RANGE HOLD switches to dBm and on (in), respectively.

## NOTE

*The next step sets the A-D log threshold. When the specified indication ( $-10.00$  dBm) is obtained, the digital readout should be just on the verge of blanking, i.e., the readout may randomly alternate between  $-10.00$  and UNDER RANGE,  $-1$ .*

9. Set the Range Calibrator RANGE switch to  $-10$  dBm and adjust the power meter LZR, A3R59, for  $-10$  dBm.
10. Set the Power Meter RANGE HOLD switch to off (out) and the Range Calibrator RANGE switch to 1 mW.
11. Adjust Power Meter LFS potentiometer A3R48 so that the digital readout indicates  $-0.00$ .
12. Set the Power Meter MODE switch to WATT and adjust MTR potentiometer A3R17 so that the pointer is aligned half way between the last two marks on the meter face.

## 5-21. POWER REFERENCE OSCILLATOR FREQUENCY ADJUSTMENT

## NOTE

*Adjustment of the Power Reference Oscillator frequency may also affect the output level of the oscillator. Thus after the frequency is adjusted to  $50.0 \pm 0.5$  MHz, the output level should be checked as described in Section IV. A procedure for adjusting the output to the specified level is provided in the next paragraph.*

REFERENCE: Service Sheet 14.

DESCRIPTION: Variable inductor A8L1 is adjusted to set the power reference oscillator output frequency to  $50.0 \pm 0.5$  MHz.



Figure 5-6. Power Reference Oscillator Frequency Adjustment Setup

## ADJUSTMENTS

## 5-21. POWER REFERENCE OSCILLATOR FREQUENCY ADJUSTMENT (cont'd)

EQUIPMENT: Counter . . . . . HP 5315A

- PROCEDURE:
1. Set the Power Meter LINE switch to ON (in) and the POWER REF switch to off (out).
  2. Set up the counter to measure frequency and connect the equipment as shown in Figure 5-6.
  3. Set the Power Meter POWER REF switch to ON (in) and observe the indication on the counter. If it is  $50.0 \pm 0.5$  MHz, no adjustment of the power reference oscillator frequency is necessary. If it is not within these limits, adjust the power reference oscillator frequency as described in steps 4 through 9.
  4. Remove the Power Meter top cover.

**CAUTION**

*Take care not to ground the +15V or -15V inputs to the power reference oscillator when performing the following steps. Grounding either of these inputs could damage the power reference oscillator, and/or the power supply.*

5. Grasp the power reference oscillator assembly firmly, and remove the four screws which secure it to the Power Meter chassis.
6. Tilt the power reference oscillator assembly to gain access to the circuit board underneath the metal cover, and adjust A8L1 to obtain a  $50.00 \pm 0.5$  MHz indication on the counter.
7. Reposition the power reference oscillator on the Power Meter chassis but do not replace the mounting screws.
8. Observe the indication on the counter. If it is  $50.0 \pm 0.5$  MHz, the adjustment procedure is complete. If it is not within these limits, repeat steps 6 and 7 except offset the power reference oscillator frequency as required to obtain a  $50.0 \pm 0.5$  MHz indication on the counter when the power reference oscillator assembly is repositioned on the Power Meter chassis.
9. Replace the four screws which secure the power reference oscillator to the Power Meter chassis.

## ADJUSTMENTS

## 5-22. POWER REFERENCE OSCILLATOR LEVEL ADJUSTMENT

REFERENCE: Service Sheet 14.

DESCRIPTION: The power reference oscillator output is factory-adjusted to  $1 \text{ mW} \pm 0.7\%$  using a special measurement system accurate to 0.5% (traceable to the National Bureau of Standards) and allowing for a 0.2% transfer error. To ensure maximum accuracy in readjusting the power reference oscillator, the following procedure provides step-by-step instructions for using specified Hewlett-Packard instruments of known capability. If equivalent instruments are used, signal acquisition criteria may vary and reference should be made to the manufacturer's guidelines for operating the equipment.

## NOTE

*The Power Meter may be returned to the nearest HP office to have the power reference oscillator checked and/or adjusted. Refer to Section II, PACKAGING.*

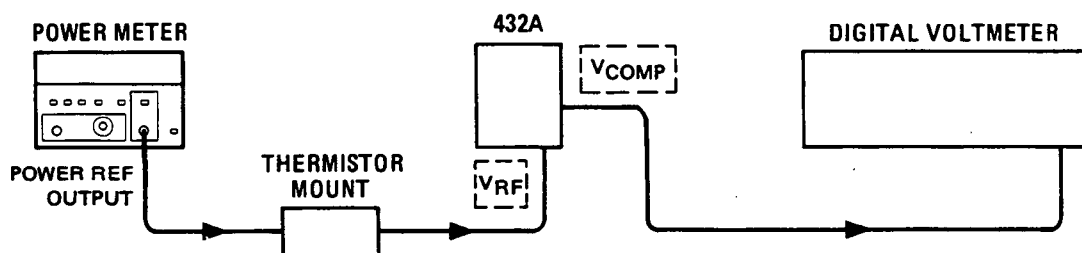

Figure 5-7. Power Reference Oscillator Level Adjustment Setup

EQUIPMENT: Power Meter . . . . . HP 432A  
 Thermistor Mount . . . . . HP 478A-H75  
 Digital Voltmeter (DVM). . . . . HP 3456A

- PROCEDURE:
1. Set up the DVM to measure resistance and connect the DVM between the  $V_{RF}$  connector on the rear panel of the 432A and pin 1 on the thermistor mount end of the 432A interconnect cable.
  2. Round off the DVM indication to two decimal places and record this value as the internal bridge resistance ( $R$ ) of the 432A (approximately 200 ohms).
  3. Connect the 432A to the Power Meter as shown in Figure 5-7.
  4. Set the Power Meter LINE switch to ON (in) and the POWER REF switch to off (out). Then wait thirty minutes for the 432A thermistor mount to stabilize before proceeding to the next step.
  5. Set the 432A RANGE switch to COARSE ZERO and adjust the front-panel COARSE ZERO control to obtain a zero meter indication.
  6. Fine zero the 432A on the most sensitive range, then set the 432A RANGE switch to 1 mW.

## ADJUSTMENTS

## 5-22. POWER REFERENCE OSCILLATOR LEVEL ADJUSTMENT (cont'd)

## NOTE

*Ensure that the DVM input leads are isolated from chassis ground when performing the next step.*

7. Set up the DVM to measure microvolts and connect the positive and negative inputs leads, respectively, to the  $V_{\text{COMP}}$  and  $V_{\text{RF}}$  connectors on the rear panel of the 432A.
8. Observe the indication on the DVM. If less than 400 microvolts, proceed to the next step. If 400 microvolts or greater, press and hold the 432A FINE ZERO switch and adjust the COARSE ZERO control so that the DVM indicates 200 microvolts or less. Then release the FINE ZERO switch and proceed to the next step.
9. Round off the DVM indication to the nearest microvolt and record this value as  $V_0$ .
10. Disconnect the DVM negative input lead from the  $V_{\text{RF}}$  connector on the 432A and reconnect it to chassis ground.
11. Set the Power Meter POWER REF switch to ON (in) and record the indication observed on the DVM as  $V_{\text{COMP}}$ .
12. Disconnect the DVM negative input lead from chassis ground and reconnect it to the  $V_{\text{RF}}$  connector on the rear panel of the 432A. The DVM is not set up to measure  $V_1$  which represents the power reference oscillator output level.
13. Calculate the value of  $V_1$  equal to 1 milliwatt from the following equation:

$$V_1 - V_0 = V_{\text{COMP}} - \sqrt{(V_{\text{COMP}})^2 - (10^{-3})(4R)(\text{EFFECTIVE EFFICIENCY})}$$

where:

$V_0$  = previously recorded value

$V_{\text{COMP}}$  = previously recorded value

$10^{-3}$  = 1 milliwatt

R = previously recorded value

EFFECTIVE EFFICIENCY = value for thermistor mount at 50 MHz (traceable to the National Bureau of Standards).

14. Remove the Power Meter top cover and adjust LEVEL ADJUST potentiometer A8R4 so that the DVM indicates the calculated value of  $V_1$ .

## ADJUSTMENTS

## 5-22. POWER REFERENCE OSCILLATOR LEVEL ADJUSTMENT (cont'd)

## TYPICAL

## CALCULATIONS:

## 1. ACCURACY:

DVM Measurements:	$(V_{\text{COMP}})$	$\pm 0.018\%$
(HP 3490A -90 days, $23^\circ\text{C} \pm 5^\circ\text{C}$ )	$(V_1 - V_0)$	$\pm 0.023\%$
	(R)	$\pm 0.03\%$

Math Assumptions :  $\pm 0.01\%$

EFFECTIVE EFFICIENCY CAL (NBS):  $\pm 0.5\%$

MISMATCH UNCERTAINTY :

(Source & Mount SWR  $\leq 1.05$ )  $\pm 0.1\%$

$\leq \pm 0.7\%$

## 2. MATH ASSUMPTIONS:

$$P_{\text{RF}} = \frac{2V_{\text{COMP}}(V_1 - V_0) + V_0^2 - V_1^2}{(4R) \text{ (EFFECTIVE EFFICIENCY)}}$$

$$\text{Assume: } V_0^2 - V_1^2 = (V_1 - V_0)^2$$

$$-(V_1 - V_0)^2 = -V_1^2 + 2V_1V_0 - V_0^2$$

$$\text{Want: } V_0^2 - V_1^2$$

$$\therefore \text{error} = (V_1^2 + 2V_1V_0 - V_0^2) - (V_0^2 - V_1^2) = -2V_0^2 + 2V_1V_0 = 2V_0(V_1 - V_0)$$

if  $2V_0(V_1 - V_0) \ll 2V_{\text{COMP}}(V_1 - V_0)$  i.e.,  $V_0 \ll V_{\text{COMP}}$ , error is negligible.

$V_{\text{COMP}} \sim 4$  volts. If  $V_0 < 400 \mu\text{V}$ , error is  $< 0.01\%$ .

(typically  $V_0$  can be set to  $< 50 \mu\text{V}$ ).

3. Derivation of Formula for  $V_1 - V_0$ 

$$P_{\text{RF}} = \frac{2V_{\text{COMP}}(V_1 - V_0) + V_0^2 - V_1^2}{(4R) \text{ (EFFECTIVE EFFICIENCY)}}$$

$$\text{Desired } P_{\text{RF}} = 1 \text{ mW} = 10^{-3}$$

$$\therefore 10^{-3} = \frac{2V_{\text{COMP}}(V_1 - V_0) + V_0^2 - V_1^2}{(4R) \text{ (EFFECTIVE EFFICIENCY)}}$$

$$\text{Let } (4R) \text{ (EFFECTIVE EFFICIENCY)} (10^{-3}) = K$$

ADJUSTMENTS

5-22. POWER REFERENCE OSCILLATOR LEVEL ADJUSTMENT (cont'd)

Substitute  $-(V_1 - V_0)^2$  for  $V_0^2 - V_1^2$  (see Math Assumptions under Accuracy)

$$\text{Then } 0 = (V_1 - V_0)^2 - 2V_{\text{COMP}}(V_1 - V_0) + K$$

$$\text{or } V_1 - V_0 = V_{\text{COMP}} - \sqrt{(V_{\text{COMP}})^2 - K}$$

5-23. POWER SUPPLY ADJUSTMENTS†

REFERENCE: See Service Sheet 15.

DESCRIPTION: While the Power Meter is measuring an equivalent 10 mW signal from the 11683A Range Calibrator, the +15V supply is adjusted for a Power Meter indication of 9.99 mW to 10.01 mW. Then the range to range accuracy is checked (performance test 4-11). Finally, if all ranges are within limits, the +15V and -15V supplies are measured with a digital voltmeter.

EQUIPMENT: Digital Voltmeter (DVM). . . . HP 3456A  
 Calibrator. . . . . HP 11683A

- PROCEDURE:
1. Set the Power Meter switches as follows:
    - CAL FACTOR % . . . . . 100
    - POWER REF . . . . . off (out)
    - MODE . . . . . WATT
    - RANGE HOLD . . . . . off (out)
    - LINE . . . . . ON (in)
  2. Set the Range Calibrator switches as follows:
    - FUNCTION . . . . . CALIBRATE
    - POLARITY . . . . . NORMAL
    - RANGE . . . . . 1 mW
    - LINE . . . . . ON (in)
  3. Connect the Power Meter to the Range Calibrator.
  4. Zero the Power Meter:
    - a. Set the Range Calibrator FUNCTION switch to STANDBY.
    - b. Press and hold the Power Meter SENSOR ZERO switch and wait for the digital readout to stabilize.
    - c. Release the Power Meter SENSOR ZERO switch; wait for the ZERO lamp to go out before proceeding.
    - d. Set the Range Calibrator FUNCTION switch to CALIBRATE.
    - e. Adjust CAL ADJ for 1.00 mW.

†Refer to Section VII, Manual Changes, for backdating information.



## ADJUSTMENTS

---

### 5-23. POWER SUPPLY ADJUSTMENTS (cont'd)

- f. Set the Range Calibrator RANGE Switch to 10 mW.
5. Adjust A9R3 (+15V) for a Power Meter indication of 9.99 mW to 10.01 mW.
6. Check Power Meter range-to-range accuracy (Performance Test 4-11).
7. Measure and record the dc voltage at A9TP3 (-15V). The voltage should be between -15.5V and -14.5V.
8. Measure the dc voltage at A9TP4 (+15V). This voltage should be between +14.5 and +15.5 volts dc.

## SECTION VI REPLACEABLE PARTS

### 6-1. INTRODUCTION

6-2. This section contains information for ordering parts. Table 6-1 lists abbreviations used in the parts list and throughout the manual. Table 6-2 lists all replaceable parts in reference designation order. Table 6-3 contains the names and addresses that correspond with the manufacturers' code numbers.

### 6-3. ABBREVIATIONS

6-4. Table 6-1 lists abbreviations used in the parts list, schematics and throughout the manual. In some cases, two forms of the abbreviation are used, one all in capital letters, and one partial or no capitals. This occurs because the abbreviations in the parts list are always all capitals. However, in the schematics and other parts of the manual, other abbreviation forms are used with both lower case and upper case letters.

### 6-5. REPLACEABLE PARTS LIST

6-6. Table 6-2 is the list of replaceable parts and is organized as follows:

- a. Electrical assemblies and their components in alpha-numerical order by reference designation.
- b. Chassis-mounted parts in alpha-numerical order by reference designation.
- c. Miscellaneous parts.

The information given for each part consists of the following:

- a. The Hewlett-Packard part number.
- b. The check digit (CD).
- c. The total quantity (Qty) used in the instrument.
- d. The description of the part.
- e. A typical manufacturer of the part in a five-digit code.
- f. The manufacturer's number for the part.

The total quantity for each part is given only once at the first appearance of the part number in the list.

### 6-7. ORDERING INFORMATION

6-8. To order a part listed in the replaceable parts table, quote the Hewlett-Packard part number, indicate the quantity required, and address the order to the nearest Hewlett-Packard office.

6-9. To order a part that is not listed in the replaceable parts table, include the instrument model number, instrument serial number, the description and function of the part, and the number of parts required. Address the order to the nearest Hewlett-Packard office.

### 6-10. PARTS PROVISIONING

6-11. Stocking spare parts for an instrument is often done to ensure quick return to service after a malfunction occurs. Hewlett-Packard has a Spare Parts Kit available for this purpose. The kit consists of selected replaceable assemblies and components for this instrument. The contents of the kit and the Recommended Spares list are based on failure reports and repair data, and parts support for one year. A complimentary Recommended Spares list for this instrument may be obtained on request and the Spare Parts Kit may be ordered through your nearest Hewlett-Packard office.

### 6-12. DIRECT MAIL ORDER SYSTEM

6-13. Within the USA, Hewlett-Packard can supply parts through a direct mail order system. Advantages of using the system are:

- a. Direct ordering and shipment from the HP Parts Center in Mountain View, California.
- b. No maximum or minimum on any mail order (there is a minimum order amount for parts ordered through a local HP office when the orders require billing and invoicing).
- c. Prepaid transportation (there is a small handling charge for each order).
- d. No invoices — to provide these advantages, a check or money order must accompany each order.

6-14. Mail order forms and specific ordering information is available through your local HP office. Addresses and phone numbers are located at the back of this manual.

Table 6-1. Reference Designations and Abbreviations (1 of 2)

REFERENCE DESIGNATIONS

A . . . . . assembly	E . . . . . miscellaneous electrical part	P . . . . . electrical connector (movable portion); plug	U . . . . . integrated circuit; microcircuit
AT . . . . . attenuator; isolator; termination	F . . . . . fuse	Q . . . . . transistor; SCR; triode thyristor	V . . . . . electron tube
B . . . . . fan; motor	FL . . . . . filter	R . . . . . resistor	VR . . . . . voltage regulator; breakdown diode
BT . . . . . battery	H . . . . . hardware	RT . . . . . thermistor	W . . . . . cable; transmission path; wire
C . . . . . capacitor	HY . . . . . circulator	S . . . . . switch	X . . . . . socket
CP . . . . . coupler	J . . . . . electrical connector (stationary portion); jack	T . . . . . transformer	Y . . . . . crystal unit (piezo-electric or quartz)
CR . . . . . diode; diode thyristor; varactor	K . . . . . relay	TB . . . . . terminal board	Z . . . . . tuned cavity; tuned circuit
DC . . . . . directional coupler	L . . . . . coil; inductor	TC . . . . . thermocouple	
DL . . . . . delay line	M . . . . . meter	TP . . . . . test point	
DS . . . . . annunciator; signaling device (audible or visual); lamp; LED	MP . . . . . miscellaneous mechanical part		

ABBREVIATIONS

A . . . . . ampere	COEF . . . . . coefficient	EDP . . . . . electronic data processing	INT . . . . . internal
ac . . . . . alternating current	COM . . . . . common	ELECT . . . . . electrolytic	kg . . . . . kilogram
ACCESS . . . . . accessory	COMP . . . . . composition	ENCAP . . . . . encapsulated	kHz . . . . . kilohertz
ADJ . . . . . adjustment	COMPL . . . . . complete	EXT . . . . . external	k $\Omega$ . . . . . kilohm
A/D . . . . . analog-to-digital	CONN . . . . . connector	F . . . . . farad	kV . . . . . kilovolt
AF . . . . . audio frequency	CP . . . . . cadmium plate	FET . . . . . field-effect transistor	lb . . . . . pound
AFC . . . . . automatic frequency control	CRT . . . . . cathode-ray tube	F/F . . . . . flip-flop	LC . . . . . inductance-capacitance
AGC . . . . . automatic gain control	CTL . . . . . complementary transistor logic	FH . . . . . flat head	LED . . . . . light-emitting diode
AL . . . . . aluminum	CW . . . . . continuous wave	FIL H . . . . . fillister head	LF . . . . . low frequency
ALC . . . . . automatic level control	cw . . . . . clockwise	FM . . . . . frequency modulation	LG . . . . . long
AM . . . . . amplitude modulation	cm . . . . . centimeter	FP . . . . . front panel	LH . . . . . left hand
AMPL . . . . . amplifier	D/A . . . . . digital-to-analog	FREQ . . . . . frequency	LIM . . . . . limit
APC . . . . . automatic phase control	dB . . . . . decibel	FXD . . . . . fixed	LIN . . . . . linear taper (used in parts list)
ASSY . . . . . assembly	dBm . . . . . decibel referred to 1 mW	g . . . . . gram	lin . . . . . linear
AUX . . . . . auxiliary	dc . . . . . direct current	GE . . . . . germanium	LK WASH . . . . . lock washer
avg . . . . . average	deg . . . . . degree (temperature interval or difference)	GHz . . . . . gigahertz	LO . . . . . low; local oscillator
AWG . . . . . American wire gauge	° . . . . . degree (plane angle)	GL . . . . . glass	LOG . . . . . logarithmic taper (used in parts list)
BAL . . . . . balance	°C . . . . . degree Celsius (centigrade)	GRD . . . . . ground(ed)	log . . . . . logarithm(ic)
BCD . . . . . binary coded decimal	°F . . . . . degree Fahrenheit	H . . . . . henry	LPF . . . . . low pass filter
BD . . . . . board	K . . . . . degree Kelvin	h . . . . . hour	LV . . . . . low voltage
BE CU . . . . . beryllium copper	DEPC . . . . . deposited carbon	HET . . . . . heterodyne	m . . . . . meter (distance)
BFO . . . . . beat frequency oscillator	DET . . . . . detector	HEX . . . . . hexagonal	mA . . . . . milliampere
BH . . . . . binder head	diam . . . . . diameter	HD . . . . . head	MAX . . . . . maximum
BKDN . . . . . breakdown	DIA . . . . . diameter (used in parts list)	HDW . . . . . hardware	M $\Omega$ . . . . . megohm
BP . . . . . bandpass	DIFF AMPL . . . . . differential amplifier	HF . . . . . high frequency	MEG . . . . . meg (10 <sup>6</sup> ) (used in parts list)
BPF . . . . . bandpass filter	div . . . . . division	HG . . . . . mercury	MET FLM . . . . . metal film
BRS . . . . . brass	DPDT . . . . . double-pole, double-throw	HI . . . . . high	MET OX . . . . . metallic oxide
BWO . . . . . backward-wave oscillator	DR . . . . . drive	HP . . . . . Hewlett-Packard	MF . . . . . medium frequency; microfarad (used in parts list)
CAL . . . . . calibrate	DSB . . . . . double sideband	HPF . . . . . high pass filter	MFR . . . . . manufacturer
ccw . . . . . counter-clockwise	DTL . . . . . diode transistor logic	HR . . . . . hour (used in parts list)	mg . . . . . milligram
CER . . . . . ceramic	DVM . . . . . digital voltmeter	HV . . . . . high voltage	MHz . . . . . megahertz
CHAN . . . . . channel	ECL . . . . . emitter coupled logic	Hz . . . . . Hertz	mH . . . . . millihenry
cm . . . . . centimeter	EMF . . . . . electromotive force	IC . . . . . integrated circuit	mho . . . . . mho
CMO . . . . . cabinet mount only		ID . . . . . inside diameter	MIN . . . . . minimum
COAX . . . . . coaxial		IF . . . . . intermediate frequency	min . . . . . minute (time)
		IMPG . . . . . impregnated	... . . . . minute (plane angle)
		in . . . . . inch	MINAT . . . . . miniature
		INCD . . . . . incandescent	mm . . . . . millimeter
		INCL . . . . . include(s)	
		INP . . . . . input	
		INS . . . . . insulation	

NOTE

All abbreviations in the parts list will be in upper-case.

Table 6-1. Reference Designations and Abbreviations (2 of 2)

MOD . . . . . modulator	OD . . . . . outside diameter	PWV . . . . . peak working voltage	TD . . . . . time delay
MOM . . . . . momentary	OH . . . . . oval head	RC . . . . . resistance-capacitance	TERM . . . . . terminal
MOS . . . . . metal-oxide semiconductor	OP AMPL . . . . . operational amplifier	RECT . . . . . rectifier	TFT . . . . . thin-film transistor
ms . . . . . millisecond	OPT . . . . . option	REF . . . . . reference	TGL . . . . . toggle
MTG . . . . . mounting	OSC . . . . . oscillator	REG . . . . . regulated	THD . . . . . thread
MTR . . . . . meter (indicating device)	OX . . . . . oxide	REPL . . . . . replaceable	THRU . . . . . through
mV . . . . . millivolt	oz . . . . . ounce	RF . . . . . radio frequency	TI . . . . . titanium
mVac . . . . . millivolt, ac	$\Omega$ . . . . . ohm	RFI . . . . . radio frequency interference	TOL . . . . . tolerance
mVdc . . . . . millivolt, dc	P . . . . . peak (used in parts list)	RH . . . . . round head; right hand	TRIM . . . . . trimmer
mVpk . . . . . millivolt, peak	PAM . . . . . pulse-amplitude modulation	RLC . . . . . resistance-inductance-capacitance	TSTR . . . . . transistor
mVp-p . . . . . millivolt, peak-to-peak	PC . . . . . printed circuit	RMO . . . . . rack mount only	TTL . . . . . transistor-transistor logic
mVrms . . . . . millivolt, rms	PCM . . . . . pulse-code modulation; pulse-count modulation	rms . . . . . root-mean-square	TV . . . . . television
mW . . . . . milliwatt	PDM . . . . . pulse-duration modulation	RND . . . . . round	TVI . . . . . television interference
MUX . . . . . multiplex	pF . . . . . picofarad	ROM . . . . . read-only memory	TWT . . . . . traveling wave tube
MY . . . . . mylar	PH BRZ . . . . . phosphor bronze	R&P . . . . . rack and panel	U . . . . . micro ( $10^6$ ) (used in parts list)
$\mu$ A . . . . . microampere	PHL . . . . . Phillips	RWV . . . . . reverse working voltage	UF . . . . . microfarad (used in parts list)
$\mu$ F . . . . . microfarad	PIN . . . . . positive-intrinsic-negative	S . . . . . scattering parameter	UHF . . . . . ultrahigh frequency
$\mu$ H . . . . . microhenry	PIV . . . . . peak inverse voltage	s . . . . . second (time)	UNREG . . . . . unregulated
$\mu$ mho . . . . . micromho	pk . . . . . peak	" . . . . . second (plane angle)	V . . . . . volt
$\mu$ s . . . . . microsecond	PL . . . . . phase lock	S-B . . . . . slow-blow (fuse) (used in parts list)	VA . . . . . voltampere
$\mu$ V . . . . . microvolt	PLO . . . . . phase lock oscillator	SCR . . . . . silicon controlled rectifier; screw	Vac . . . . . volts, ac
$\mu$ Vac . . . . . microvolt, ac	PM . . . . . phase modulation	SE . . . . . selenium	VAR . . . . . variable
$\mu$ Vdc . . . . . microvolt, dc	PNP . . . . . positive-negative-positive	SECT . . . . . sections	VCO . . . . . voltage-controlled oscillator
$\mu$ Vpk . . . . . microvolt, peak	P/O . . . . . part of	SEMICON . . . . . semiconductor	Vdc . . . . . volts, dc
$\mu$ Vp-p . . . . . microvolt, peak-to-peak	POLY . . . . . polystyrene	SHF . . . . . superhigh frequency	VDCW . . . . . volts, dc, working (used in parts list)
$\mu$ Vrms . . . . . microvolt, rms	PORC . . . . . porcelain	SI . . . . . silicon	V(F) . . . . . volts, filtered
$\mu$ W . . . . . microwatt	POS . . . . . positive; position(s) (used in parts list)	SIL . . . . . silver	VFO . . . . . variable-frequency oscillator
nA . . . . . nanoampere	POSN . . . . . position	SL . . . . . slide	VHF . . . . . very-high frequency
NC . . . . . no connection	POT . . . . . potentiometer	SNR . . . . . signal-to-noise ratio	Vpk . . . . . volts, peak
N/C . . . . . normally closed	p-p . . . . . peak-to-peak	SPDT . . . . . single-pole, double-throw	Vp-p . . . . . volts, peak-to-peak
NE . . . . . neon	PP . . . . . peak-to-peak (used in parts list)	SPG . . . . . spring	Vrms . . . . . volts, rms
NEG . . . . . negative	PPM . . . . . pulse-position modulation	SR . . . . . split ring	VSWR . . . . . voltage standing wave ratio
nF . . . . . nanofarad	PREAMPL . . . . . preamplifier	SPST . . . . . single-pole, single-throw	VTO . . . . . voltage-tuned oscillator
NI PL . . . . . nickel plate	PRF . . . . . pulse-repetition frequency	SSB . . . . . single sideband	VTVM . . . . . vacuum-tube voltmeter
N/O . . . . . normally open	PRR . . . . . pulse repetition rate	SST . . . . . stainless steel	V(X) . . . . . volts, switched
NOM . . . . . nominal	ps . . . . . picosecond	STL . . . . . steel	W . . . . . watt
NORM . . . . . normal	PT . . . . . point	SQ . . . . . square	W/ . . . . . with
NPN . . . . . negative-positive-negative	PTM . . . . . pulse-time modulation	SWR . . . . . standing-wave ratio	WIV . . . . . working inverse voltage
NPO . . . . . negative-positive zero (zero temperature coefficient)	PWM . . . . . pulse-width modulation	SYNC . . . . . synchronize	WW . . . . . wirewound
NRFR . . . . . not recommended for field replacement		T . . . . . timed (slow-blow fuse)	W/O . . . . . without
NSR . . . . . not separately replaceable		TA . . . . . tantalum	YIG . . . . . yttrium-iron-garnet
ns . . . . . nanosecond		TC . . . . . temperature compensating	Z <sub>0</sub> . . . . . characteristic impedance
nW . . . . . nanowatt			
OBD . . . . . order by description			

NOTE

All abbreviations in the parts list will be in upper-case.

MULTIPLIERS

Abbreviation	Prefix	Multiple
T	tera	10 <sup>12</sup>
G	giga	10 <sup>9</sup>
M	mega	10 <sup>6</sup>
k	kilo	10 <sup>3</sup>
da	deka	10
d	deci	10 <sup>-1</sup>
c	centi	10 <sup>-2</sup>
m	milli	10 <sup>-3</sup>
$\mu$	micro	10 <sup>-6</sup>
n	nano	10 <sup>-9</sup>
p	pico	10 <sup>-12</sup>
f	femto	10 <sup>-15</sup>
a	atto	10 <sup>-18</sup>

Table 6-2. Replaceable Parts

Reference Designation	HP Part Number	C D	Qty	Description	Mfr Code	Mfr Part Number
A1	00436-60020	2	1	FRONT PANEL ASSEMBLY	28480	00436-60020
A1A1	00436-60007	5	1	DISPLAY ASSEMBLY	28480	00436-60007
A1A1C1	0180-0197	8	4	CAPACITOR-FXD 2.2UF+-10% 20VDC TA	56289	1500225X9020A2
A1A1C2	0180-0228	6	1	CAPACITOR-FXD 22UF+-10% 15VDC TA	56289	1500226X9015B2
A1A1CR1	1901-0518	8	2	DIODE-SM SIG SCHOTTKY	28480	1901-0518
A1A1CR2	1901-0518	8		DIODE-SM SIG SCHOTTKY	28480	1901-0518
A1A1DS1	1990-0450	4	10	LED-LAMP LUM-INT=800UCD IF=50MA-MAX	28480	5082-4484
A1A1DS2	1990-0450	4		LED-LAMP LUM-INT=800UCD IF=50MA-MAX	28480	5082-4484
A1A1DS3	1990-0450	4		LED-LAMP LUM-INT=800UCD IF=50MA-MAX	28480	5082-4484
A1A1DS4	1990-0450	4		LED-LAMP LUM-INT=800UCD IF=50MA-MAX	28480	5082-4484
A1A1DS5	1990-0450	4		LED-LAMP LUM-INT=800UCD IF=50MA-MAX	28480	5082-4484
A1A1DS6	1990-0450	4		LED-LAMP LUM-INT=800UCD IF=50MA-MAX	28480	5082-4484
A1A1DS7	1990-0450	4		LED-LAMP LUM-INT=800UCD IF=50MA-MAX	28480	5082-4484
A1A1DS8	1990-0450	4		LED-LAMP LUM-INT=800UCD IF=50MA-MAX	28480	5082-4484
A1A1DS9	1990-0450	4		LED-LAMP LUM-INT=800UCD IF=50MA-MAX	28480	5082-4484
A1A1DS10	1990-0450	4		LED-LAMP LUM-INT=800UCD IF=50MA-MAX	28480	5082-4484
A1A1J1	1251-3944	1	1	CONNECTOR 5-PIN M POST TYPE	28480	1251-3944
A1A1J2	1200-0473	8	6	SOCKET-IC 16-CONT DIP DIP-SLDR	28480	1200-0473
A1A1J3	1200-0473	8		SOCKET-IC 16-CONT DIP DIP-SLDR	28480	1200-0473
A1A1Q1	1853-0020	4	20	TRANSISTOR PNP SI PD=300MW FT=150MHZ	28480	1853-0020
A1A1R1	1810-0151	2	12	NETWORK-RES 7-SIP10.0K OHM X 6	91637	CSP07C07-103J
A1A1R2	0757-0401	0	7	RESISTOR 100 1% .125W F TC=0+-100	24546	C4-1/8-T0-101-F
A1A1R3	0698-3441	8	9	RESISTOR 215 1% .125W F TC=0+-100	24546	C4-1/8-T0-215R-F
A1A1R4	0698-3441	8		RESISTOR 215 1% .125W F TC=0+-100	24546	C4-1/8-T0-215R-F
A1A1R5	0698-3441	8		RESISTOR 215 1% .125W F TC=0+-100	24546	C4-1/8-T0-215R-F
A1A1R6	0698-3441	8		RESISTOR 215 1% .125W F TC=0+-100	24546	C4-1/8-T0-215R-F
A1A1R7	0698-3441	8		RESISTOR 215 1% .125W F TC=0+-100	24546	C4-1/8-T0-215R-F
A1A1U1	1820-1361	9	4	IC DCDR TTL BCD-T0-7-SEG 4-T0-7-LINE	07263	9374PC
A1A1U2	1820-1361	9		IC DCDR TTL BCD-T0-7-SEG 4-T0-7-LINE	07263	9374PC
A1A1U3	1820-1361	9		IC DCDR TTL BCD-T0-7-SEG 4-T0-7-LINE	07263	9374PC
A1A1U4	1820-1361	9		IC DCDR TTL BCD-T0-7-SEG 4-T0-7-LINE	07263	9374PC
A1A1U5	1820-0174	0	2	IC INV TTL HEX	01295	SN7404N
A1A1U6	1990-0490	2	5	DISPLAY-NUM-SEG 1-CHAR .3-H	28480	5082-7730, CAT D
A1A1U7	1990-0490	2		DISPLAY-NUM-SEG 1-CHAR .3-H	28480	5082-7730, CAT D
A1A1U8	1990-0490	2		DISPLAY-NUM-SEG 1-CHAR .3-H	28480	5082-7730, CAT D
A1A1U9	1990-0490	2		DISPLAY-NUM-SEG 1-CHAR .3-H	28480	5082-7730, CAT D
A1A1U10	1990-0490	2		DISPLAY-NUM-SEG 1-CHAR .3-H	28480	5082-7730, CAT D
A1A1XU1	1200-0473	8		SOCKET-IC 16-CONT DIP DIP-SLDR	28480	1200-0473
A1A1XU2	1200-0473	8		SOCKET-IC 16-CONT DIP DIP-SLDR	28480	1200-0473
A1A1XU3	1200-0473	8		SOCKET-IC 16-CONT DIP DIP-SLDR	28480	1200-0473
A1A1XU4	1200-0473	8		SOCKET-IC 16-CONT DIP DIP-SLDR	28480	1200-0473
A1A1XU5				NOT ASSIGNED		
A1A1XU6	1200-0508	0	6	SOCKET-IC 14-CONT DIP-SLDR	28480	1200-0508
A1A1XU7	1200-0508	0		SOCKET-IC 14-CONT DIP-SLDR	28480	1200-0508
A1A1XU8	1200-0508	0		SOCKET-IC 14-CONT DIP-SLDR	28480	1200-0508
A1A1XU9	1200-0508	0		SOCKET-IC 14-CONT DIP-SLDR	28480	1200-0508
A1A1XU10	1200-0508	0		SOCKET-IC 14-CONT DIP-SLDR	28480	1200-0508
A1A1 MISCELLANEOUS PARTS						
	0520-0128	7	2	SCREW-MACH 2-56 .25-IN-LG PAN-HD-POZI	00000	ORDER BY DESCRIPTION
	2190-0045	8	2	WASHER-LK HLCL NO. 2 .088-IN-ID	28480	2190-0045
	3050-0079	3	1	WASHER-FL NM NO. 2 .094-IN-ID .188-IN-OD	28480	3050-0079
	3050-0098	6	1	WASHER-FL MTLCL NO. 2 .094-IN-ID	28480	3050-0098
A1A2	00436-60008	6	1	PUSHBUTTON SWITCH ASSEMBLY	28480	00436-60008
A1A2J1	1200-0508	0		SOCKET-IC 14-CONT DIP-SLDR	28480	1200-0508
A1A2MP1- A1A2MP6	0370-2486	5	6	PUSHBUTTON .230X.390X.397 IN H: JADE	28480	0370-2486
A1A2R1	0757-0438	3	5	RESISTOR 5.11K 1% .125W F TC=0+-100	24546	C4-1/8-T0-5111-F
A1A2R2	0757-0442	9		RESISTOR 10K 1% .125W F TC=0+-100	24546	C4-1/8-T0-1002-F
A1A2R3	0757-0442	9		RESISTOR 10K 1% .125W F TC=0+-100	24546	C4-1/8-T0-1002-F
A1A2R4	0757-0442	9		RESISTOR 10K 1% .125W F TC=0+-100	24546	C4-1/8-T0-1002-F

See introduction to this section for ordering information  
 \*Indicates factory selected value  
 †Backdating information in Section VII

Table 6-2. Replaceable Parts

Reference Designation	HP Part Number	C D	Qty	Description	Mfr Code	Mfr Part Number
A1A2S1	3101-1901	1	1	SWITCH-PB 9-STATION 15MM C-C SPACING	28480	3101-1901
A1A2U1	1820-0175	1	2	IC INV TTL HEX 1-INP	01295	SN7405N
A1A2 MISCELLANEOUS PARTS						
	0520-0128	7		SCREW-MACH 2-56 .25-IN-LG PAN-HD-POZI	00000	ORDER BY DESCRIPTION
	2190-0045	8		WASHER-LK HLCL NO. 2 .088-IN-ID	28480	2190-0045
A1A3	00436-60027	9	1	CAL FACTOR SWITCH ASSEMBLY (INCLUDES W3)	28480	00436-60027
A1A3R1	0757-0346	2	15	RESISTOR 10 1% .125W F TC=0+-100	24546	C4-1/8-T0-10R0-F
A1A3R2	0757-0346	2		RESISTOR 10 1% .125W F TC=0+-100	24546	C4-1/8-T0-10R0-F
A1A3R3	0757-0346	2		RESISTOR 10 1% .125W F TC=0+-100	24546	C4-1/8-T0-10R0-F
A1A3R4	0757-0346	2		RESISTOR 10 1% .125W F TC=0+-100	24546	C4-1/8-T0-10R0-F
A1A3R5	0757-0346	2		RESISTOR 10 1% .125W F TC=0+-100	24546	C4-1/8-T0-10R0-F
A1A3R6	0757-0346	2		RESISTOR 10 1% .125W F TC=0+-100	24546	C4-1/8-T0-10R0-F
A1A3R7	0757-0346	2		RESISTOR 10 1% .125W F TC=0+-100	24546	C4-1/8-T0-10R0-F
A1A3R8	0757-0346	2		RESISTOR 10 1% .125W F TC=0+-100	24546	C4-1/8-T0-10R0-F
A1A3R9	0757-0346	2		RESISTOR 10 1% .125W F TC=0+-100	24546	C4-1/8-T0-10R0-F
A1A3R10	0757-0346	2		RESISTOR 10 1% .125W F TC=0+-100	24546	C4-1/8-T0-10R0-F
A1A3R11	0757-0346	2		RESISTOR 10 1% .125W F TC=0+-100	24546	C4-1/8-T0-10R0-F
A1A3R12	0757-0346	2		RESISTOR 10 1% .125W F TC=0+-100	24546	C4-1/8-T0-10R0-F
A1A3R13	0757-0346	2		RESISTOR 10 1% .125W F TC=0+-100	24546	C4-1/8-T0-10R0-F
A1A3R14	0757-0346	2		RESISTOR 10 1% .125W F TC=0+-100	24546	C4-1/8-T0-10R0-F
A1A3R15	0757-0346	2		RESISTOR 10 1% .125W F TC=0+-100	24546	C4-1/8-T0-10R0-F
A1A3R16	2100-0600	2	1	RESISTOR-TRMR SK 10% C SIDE-ADJ 22-TRN	32997	3059J-1-502M
A1A3S1	3100-3318	6	1	SWITCH-RTRY SP16T-PS 1.562-CTR-SPCG	28480	3100-3318
A1A3 MISCELLANEOUS PARTS						
	0370-2774	4	1	KNOB-BASE-SKT 1/2 JGK .25-IN-ID	28480	0370-2774
	2190-0016	3	1	WASHER-LK INTL T 3/8 IN .377-IN-ID	28480	2190-0016
	2950-0043	8	1	NUT-HEX-DBL-CHAM 3/8-32-THD .094-IN-THK	00000	ORDER BY DESCRIPTION
	3050-0032	8	1	WASHER-FL MTLCL NO. 8 .189-IN-ID	28480	3050-0032
†	3050-1167	2	1	WASHER-SPR CRVD NO. 10 .2-IN-ID	28480	3050-1167
A1M1	1120-0584	2	1	METER	28480	1120-0584
A1MP1	0590-0505	1	1	NUT-KNRLD-R 5/8-24-THD .125-IN-THK	00000	ORDER BY DESCRIPTION
A1MP2	2190-0002	7	1	WASHER-LK INTL T 11/16 IN .7-IN-ID	28480	2190-0002
A2†	00436-60039	3	1	AC GAIN ASSEMBLY	28480	00436-60039
A2C1	0180-1746	5	8	CAPACITOR-FXD 15UF+-10% 20VDC TA	56289	150D156X9020B2
A2C2	0180-1746	5		CAPACITOR-FXD 15UF+-10% 20VDC TA	56289	150D156X9020B2
A2C3	0180-2206	4	3	CAPACITOR-FXD 60UF+-10% 6VDC TA	56289	150D606X9006B2
A2C4	0180-0229	7	2	CAPACITOR-FXD 33UF+-10% 10VDC TA	56289	150D336X9010B2
A2C5	0160-0160	3	3	CAPACITOR-FXD 8200PF +-10% 200VDC POLYE	28480	0160-0160
A2C6	0180-2206	4		CAPACITOR-FXD 60UF+-10% 6VDC TA	56289	150D606X9006B2
A2C7	0180-0197	8		CAPACITOR-FXD 2.2UF+-10% 20VDC TA	56289	150D225X9020A2
A2C8	0160-2290	4	5	CAPACITOR-FXD .15UF +-10% 80VDC POLYE	28480	0160-2290
A2C9	0160-2199	2	1	CAPACITOR-FXD 30PF +-5% 300VDC MICA	28480	0160-2199
A2C10	0160-0160	3		CAPACITOR-FXD 8200PF +-10% 200VDC POLYE	28480	0160-0160
A2C11	0160-2290	4		CAPACITOR-FXD .15UF +-10% 80VDC POLYE	28480	0160-2290
A2C12	0160-0160	3		CAPACITOR-FXD 8200PF +-10% 200VDC POLYE	28480	0160-0160
A2C13	0160-2290	4		CAPACITOR-FXD .15UF +-10% 80VDC POLYE	28480	0160-2290
A2C14**†	0160-0157	8	1	CAPACITOR-FXD 4700PF +-10% 200VDC POLYE	28480	0160-0157
A2C15	0180-1746	5		CAPACITOR-FXD 15UF+-10% 20VDC TA	56289	150D156X9020B2
A2C16	0160-2055	9	11	CAPACITOR-FXD .01UF +-80-20% 100VDC CER	28480	0160-2055
A2C17	0160-2261	9	1	CAPACITOR-FXD 15PF +-5% 500VDC CER 0+-30	28480	0160-2261
A2C18	0180-0229	7		CAPACITOR-FXD 33UF+-10% 10VDC TA	56289	150D336X9010B2
A2C19†	0160-3439	5	2	CAPACITOR-FXD .039UF +-5% 200VDC	28480	0160-3439
A2C20†	0160-3439	5		CAPACITOR-FXD .039UF +-5% 200VDC	28480	0160-3439
A2C21- A2C35†				NOT ASSIGNED		

See introduction to this section for ordering information  
 \*Indicates factory selected value  
 †Backdating information in Section VII

Table 6-2. Replaceable Parts

Reference Designation	HP Part Number	C D	Qty	Description	Mfr Code	Mfr Part Number
A2CR1†	1901-0996	6	2	DIODE-SCHOTTKY SM SIG	28480	1901-0996
A2CR2†	1901-0996	6		DIODE-SCHOTTKY SM SIG	28480	1901-0996
A2CR3	1901-0040	1	7	DIODE-SWITCHING 30V 50MA 2NS DO-35	28480	1901-0040
A2Q1	1854-0003	5	1	TRANSISTOR NPN SI TO-39 PD=800MW	28480	1854-0003
A2Q2	1855-0414	4	21	TRANSISTOR J-FET 2N4393 N-CHAN D-MODE	04713	2N4393
A2Q3	1855-0414	4		TRANSISTOR J-FET 2N4393 N-CHAN D-MODE	04713	2N4393
A2Q4†	1854-0810	2	27	TRANSISTOR NPN SI PD=625MW FT=200MHZ	28480	1854-0810
A2Q5†	1854-0810	2		TRANSISTOR NPN SI PD=625MW FT=200MHZ	28480	1854-0810
A2Q6†	1854-0810	2		TRANSISTOR NPN SI PD=625MW FT=200MHZ	28480	1854-0810
A2Q7†	1854-0810	2		TRANSISTOR NPN SI PD=625MW FT=200MHZ	28480	1854-0810
A2Q8†	1854-0810	2		TRANSISTOR NPN SI PD=625MW FT=200MHZ	28480	1854-0810
A2Q9	1855-0414	4		TRANSISTOR J-FET 2N4393 N-CHAN D-MODE	04713	2N4393
A2Q10	1855-0414	4		TRANSISTOR J-FET 2N4393 N-CHAN D-MODE	04713	2N4393
A2Q11	1855-0414	4		TRANSISTOR J-FET 2N4393 N-CHAN D-MODE	04713	2N4393
A2Q12	1855-0414	4		TRANSISTOR J-FET 2N4393 N-CHAN D-MODE	04713	2N4393
A2Q13†	1854-0810	2		TRANSISTOR NPN SI PD=625MW FT=200MHZ	28480	1854-0810
A2Q14	1853-0020	4		TRANSISTOR PNP SI PD=300MW FT=150MHZ	28480	1853-0020
A2Q15				NOT ASSIGNED		
A2Q16†	1854-0810	2		TRANSISTOR NPN SI PD=625MW FT=200MHZ	28480	1854-0810
A2Q17†	1854-0810	2		TRANSISTOR NPN SI PD=625MW FT=200MHZ	28480	1854-0810
A2Q18†	1854-0810	2		TRANSISTOR NPN SI PD=625MW FT=200MHZ	28480	1854-0810
A2Q19	1853-0020	4		TRANSISTOR PNP SI PD=300MW FT=150MHZ	28480	1853-0020
A2Q20	1853-0020	4		TRANSISTOR PNP SI PD=300MW FT=150MHZ	28480	1853-0020
A2Q21	1853-0020	4		TRANSISTOR PNP SI PD=300MW FT=150MHZ	28480	1853-0020
A2Q22	1853-0020	4		TRANSISTOR PNP SI PD=300MW FT=150MHZ	28480	1853-0020
A2Q23	1853-0020	4		TRANSISTOR PNP SI PD=300MW FT=150MHZ	28480	1853-0020
A2Q24	1853-0020	4		TRANSISTOR PNP SI PD=300MW FT=150MHZ	28480	1853-0020
A2Q25	1853-0020	4		TRANSISTOR PNP SI PD=300MW FT=150MHZ	28480	1853-0020
A2Q26	1853-0020	4		TRANSISTOR PNP SI PD=300MW FT=150MHZ	28480	1853-0020
A2Q27	1853-0020	4		TRANSISTOR PNP SI PD=300MW FT=150MHZ	28480	1853-0020
A2Q28	1853-0020	4		TRANSISTOR PNP SI PD=300MW FT=150MHZ	28480	1853-0020
A2R1	0698-3450	9		RESISTOR 42.2K 1% .125W F TC=0+-100	24546	C4-1/8-T0-4222-F
A2R2	0698-3156	2	2	RESISTOR 14.7K 1% .125W F TC=0+-100	24546	C4-1/8-T0-1472-F
A2R3	0683-2265	1	1	RESISTOR 22M 5% .25W FC TC=-900/+1200	01121	CB2265
A2R4				NOT ASSIGNED		
A2R5	0757-0459	8	1	RESISTOR 56.2K 1% .125W F TC=0+-100	24546	C4-1/8-T0-5622-F
A2R6	0698-3159	5	3	RESISTOR 26.1K 1% .125W F TC=0+-100	24546	C4-1/8-T0-2612-F
A2R7**	0698-3450	9	5	RESISTOR 42.2K 1% .125W F TC=0+-100	24546	C4-1/8-T0-4222-F
A2R8	1810-0151	2		NETWORK-RES 7-SIP10.0K OHM X 6	91637	CSP07C07-103J
A2R9	0698-3441	8		RESISTOR 215 1% .125W F TC=0+-100	24546	C4-1/8-T0-215R-F
A2R10	0757-0444	1	3	RESISTOR 12.1K 1% .125W F TC=0+-100	24546	C4-1/8-T0-1212-F
A2R11	0757-0442	9		RESISTOR 10K 1% .125W F TC=0+-100	24546	C4-1/8-T0-1002-F
A2R12**	0757-0465	6	8	RESISTOR 100K 1% .125W F TC=0+-100	24546	C4-1/8-T0-1003-F
A2R13	0698-3156	2		RESISTOR 14.7K 1% .125W F TC=0+-100	24546	C4-1/8-T0-1472-F
A2R14	0698-3160	8	4	RESISTOR 31.6K 1% .125W F TC=0+-100	24546	C4-1/8-T0-3162-F
A2R15	0698-3158	4	4	RESISTOR 23.7K 1% .125W F TC=0+-100	24546	C4-1/8-T0-2372-F
A2R16	0757-0438	3		RESISTOR 5.11K 1% .125W F TC=0+-100	24546	C4-1/8-T0-5111-F
A2R17	0698-0083	8	1	RESISTOR 1.96K 1% .125W F TC=0+-100	24546	C4-1/8-T0-1961-F
A2R18*	0757-0470	3	1	RESISTOR 162K 1% .125W F TC=0+-100	24546	C4-1/8-T0-1623-F
A2R19	0757-0442	9		RESISTOR 10K 1% .125W F TC=0+-100	24546	C4-1/8-T0-1002-F
A2R20	0698-0084	9		RESISTOR 2.15K 1% .125W F TC=0+-100	24546	C4-1/8-T0-2151-F
A2R21	1810-0151	2		NETWORK-RES 7-SIP10.0K OHM X 6	91637	CSP07C07-103J
A2R22	0698-3136	8	5	RESISTOR 17.8K 1% .125W F TC=0+-100	24546	C4-1/8-T0-1782-F
A2R23	0757-0441	8	1	RESISTOR 8.25K 1% .125W F TC=0+-100	24546	C4-1/8-T0-8251-F
A2R24	0811-3351	1	1	RESISTOR 11K .025% .05W PWM TC=0+-10	28480	0811-3351
A2R25	0811-3348	6	2	RESISTOR 111.11 .025% .05W PWM TC=0+-10	28480	0811-3348
A2R26	1810-0158	9	2	NETWORK-RES 7-SIP56.0K OHM X 6	28480	1810-0158
A2R27	0698-3136	8		RESISTOR 17.8K 1% .125W F TC=0+-100	24546	C4-1/8-T0-1782-F
A2R28	0698-3150	6	2	RESISTOR 2.37K 1% .125W F TC=0+-100	24546	C4-1/8-T0-2371-F
A2R29	0698-3158	4		RESISTOR 23.7K 1% .125W F TC=0+-100	24546	C4-1/8-T0-2372-F
A2R30	0757-0464	5	1	RESISTOR 90.9K 1% .125W F TC=0+-100	24546	C4-1/8-T0-9092-F
A2R31	0698-3449	6	1	RESISTOR 28.7K 1% .125W F TC=0+-100	24546	C4-1/8-T0-2872-F
A2R32	0757-0290	5	3	RESISTOR 6.19K 1% .125W F TC=0+-100	19701	MF4C1/8-T0-6191-F
A2R33	0698-3450	9		RESISTOR 42.2K 1% .125W F TC=0+-100	24546	C4-1/8-T0-4222-F
A2R34	0757-0442	9		RESISTOR 10K 1% .125W F TC=0+-100	24546	C4-1/8-T0-1002-F
A2R35	0698-3136	8		RESISTOR 17.8K 1% .125W F TC=0+-100	24546	C4-1/8-T0-1782-F

See introduction to this section for ordering information  
 \*Indicates factory selected value  
 †Backdating information in Section VII

Table 6-2. Replaceable Parts

Reference Designation	HP Part Number	C D	Qty	Description	Mfr Code	Mfr Part Number
A2R36	0757-0289	2	2	RESISTOR 13.3K 1% .125W F TC=0+-100	19701	MF4C1/8-T0-1332-F
A2R37	0811-3348	6		RESISTOR 111.11 .025% .05W PWM TC=0+-10	28480	0811-3348
A2R38	0811-3350	0	1	RESISTOR 10K .025% .05W PWM TC=0+-10	28480	0811-3350
A2R39	0811-3349	7	1	RESISTOR 1K .025% .05W PWM TC=0+-10	28480	0811-3349
A2R40	0698-3452	1	2	RESISTOR 147K 1% .125W F TC=0+-100	24546	C4-1/8-T0-1473-F
A2R41	0757-0443	0	1	RESISTOR 11K 1% .125W F TC=0+-100	24546	C4-1/8-T0-1102-F
A2R42	1810-0151	2		NETWORK-RES 7-SIP10.0K OHM X 6	91637	CSP07C07-103J
A2R43	0698-3136	8		RESISTOR 17.8K 1% .125W F TC=0+-100	24546	C4-1/8-T0-1782-F
A2R44	0757-0280	3	7	RESISTOR 1K 1% .125W F TC=0+-100	24546	C4-1/8-T0-1001-F
A2R45	1810-0151	2		NETWORK-RES 7-SIP10.0K OHM X 6	91637	CSP07C07-103J
A2R46	0757-0280	3		RESISTOR 1K 1% .125W F TC=0+-100	24546	C4-1/8-T0-1001-F
A2R47	0757-0280	3		RESISTOR 1K 1% .125W F TC=0+-100	24546	C4-1/8-T0-1001-F
A2R48	0698-3450	9		RESISTOR 42.2K 1% .125W F TC=0+-100	24546	C4-1/8-T0-4222-F
A2R49	0698-0084	9		RESISTOR 2.15K 1% .125W F TC=0+-100	24546	C4-1/8-T0-2151-F
A2R50*	0757-0442	9	27	RESISTOR 10K 1% .125W F TC=0+-100	24546	C4-1/8-T0-1002-F
A2R51	0757-0290	5		RESISTOR 6.19K 1% .125W F TC=0+-100	19701	MF4C1/8-T0-6191-F
A2R52	0698-3450	9		RESISTOR 42.2K 1% .125W F TC=0+-100	24546	C4-1/8-T0-4222-F
A2R53	0698-3150	6		RESISTOR 2.37K 1% .125W F TC=0+-100	24546	C4-1/8-T0-2371-F
A2R54	0698-3159	5		RESISTOR 26.1K 1% .125W F TC=0+-100	24546	C4-1/8-T0-2612-F
A2R55	0757-0460	1	5	RESISTOR 61.9K 1% .125W F TC=0+-100	24546	C4-1/8-T0-6192-F
A2R56	0757-0442	9		RESISTOR 10K 1% .125W F TC=0+-100	24546	C4-1/8-T0-1002-F
A2R57	0757-0442	9		RESISTOR 10K 1% .125W F TC=0+-100	24546	C4-1/8-T0-1002-F
A2R58	0757-0442	9		RESISTOR 10K 1% .125W F TC=0+-100	24546	C4-1/8-T0-1002-F
A2R59	0757-0465	6		RESISTOR 100K 1% .125W F TC=0+-100	24546	C4-1/8-T0-1003-F
A2R60	0757-0442	9		RESISTOR 10K 1% .125W F TC=0+-100	24546	C4-1/8-T0-1002-F
A2R61	0757-0442	9		RESISTOR 10K 1% .125W F TC=0+-100	24546	C4-1/8-T0-1002-F
A2R62	0757-0485	6		RESISTOR 100K 1% .125W F TC=0+-100	24546	C4-1/8-T0-1003-F
A2R63	0698-3154	0	2	RESISTOR 4.22K 1% .125W F TC=0+-100	24546	C4-1/8-T0-4221-F
A2R64	0757-0200	7	2	RESISTOR 5.62K 1% .125W F TC=0+-100	24546	C4-1/8-T0-5621-F
A2R65	0757-0460	1		RESISTOR 61.9K 1% .125W F TC=0+-100	24546	C4-1/8-T0-6192-F
A2R66	0757-0401	0		RESISTOR 100 1% .125W F TC=0+-100	24546	C4-1/8-T0-101-F
A2R67	0757-0465	6		RESISTOR 100K 1% .125W F TC=0+-100	24546	C4-1/8-T0-1003-F
A2R68	0757-0460	1		RESISTOR 61.9K 1% .125W F TC=0+-100	24546	C4-1/8-T0-6192-F
A2R69	2100-2514	1	1	RESISTOR-TRMR 20K 10% C SIDE-ADJ 1-TRN	30983	ETS0W203
A2R70	0698-3154	0		RESISTOR 4.22K 1% .125W F TC=0+-100	24546	C4-1/8-T0-4221-F
A2R71	0698-3441	8		RESISTOR 215 1% .125W F TC=0+-100	24546	C4-1/8-T0-215R-F
A2R72	0698-3441	8		RESISTOR 215 1% .125W F TC=0+-100	24546	C4-1/8-T0-215R-F
A2R73	0698-3441	8		RESISTOR 215 1% .125W F TC=0+-100	24546	C4-1/8-T0-215R-F
A2R74	0757-0279	0	1	RESISTOR 3.16K 1% .125W F TC=0+-100	24546	C4-1/8-T0-3161-F
A2R75	0757-0200	7		RESISTOR 5.62K 1% .125W F TC=0+-100	24546	C4-1/8-T0-5621-F
A2R76	0757-0280	3		RESISTOR 1K 1% .125W F TC=0+-100	24546	C4-1/8-T0-1001-F
A2R77	0757-0422	5	1	RESISTOR 909 1% .125W F TC=0+-100	24546	C4-1/8-T0-909R-F
A2R78	0698-0085	0	3	RESISTOR 2.61K 1% .125W F TC=0+-100	24546	C4-1/8-T0-2611-F
A2R79	0698-3446	3	1	RESISTOR 383 1% .125W F TC=0+-100	24546	C4-1/8-T0-383R-F
A2R80	0698-0085	0		RESISTOR 2.61K 1% .125W F TC=0+-100	24546	C4-1/8-T0-2611-F
A2R81*†	0757-0288	1	1	RESISTOR 9.09K 1% .125W F TC=0+-100	19701	MF4C1/8-T0-9091-F
A2TP1	0360-1514	7	15	TERMINAL-STUD SGL-PIN PRESS-MTG	28480	0360-1514
A2TP2	0360-1514	7		TERMINAL-STUD SGL-PIN PRESS-MTG	28480	0360-1514
A2TP3	0360-1514	7		TERMINAL-STUD SGL-PIN PRESS-MTG	28480	0360-1514
A2TP4	0360-1514	7		TERMINAL-STUD SGL-PIN PRESS-MTG	28480	0360-1514
A2TP5	0360-1514	7		TERMINAL-STUD SGL-PIN PRESS-MTG	28480	0360-1514
A2TP6	0360-1514	7		TERMINAL-STUD SGL-PIN PRESS-MTG	28480	0360-1514
A2U1	1820-0223	0	3	IC OP AMP GP TO-99 PKG	3L585	CA301AT
A2U2	1826-0092	3	2	IC OP AMP GP DUAL TO-99 PKG	28480	1826-0092
A2U3	1820-0174	0		IC INV TTL HEX	01295	SN7404N
A2U4	1826-0161	7	1	IC OP AMP GP QUAD 14-DIP-P PKG	04713	MLM324P
A2U5	1826-0092	3		IC OP AMP GP DUAL TO-99 PKG	28480	1826-0092
A2U6†	00436-80009	9	1	IC TTL S 256-BIT ROM 40-NS 0-C	28480	00436-80009
A2U7	1818-2245	5	1	IC NMOS 4096 (4K) ROM	28480	1818-2245
A2U8	1820-0223	0		IC OP AMP GP TO-99 PKG	3L585	CA301AT
A2VR1	1902-3002	3	2	DIODE-ZNR 2.37V 5% D0-7 PD=.4W TC=-.074%	28480	1902-3002
A2VR2	1902-3002	3		DIODE-ZNR 2.37V 5% D0-7 PD=.4W TC=-.074%	28480	1902-3002

See introduction to this section for ordering information

\*Indicates factory selected value

†Backdating information in Section VII



Table 6-2. Replaceable Parts

Reference Designation	HP Part Number	C D	Qty	Description	Mfr Code	Mfr Part Number
A2 MISCELLANEOUS PARTS						
	5000-9043	6	4	PIN:P.C. BOARD EXTRACTOR	28480	5000-9043
	5040-6847	6	1	EXTRACTOR, RED	28480	5040-6847
	1460-0553	5	1	CLIP-WINDOW	28480	1460-0553
A3†	00436-60040	6	1	A-D CONVERTER ASSEMBLY	28480	00436-60040
A3A1	00436-60010	0	1	AUTO ZERO ASSEMBLY	28480	00436-60010
A3C1	0180-1746	5		CAPACITOR-FXD 15UF+-10% 20VDC TA	56289	150D156X9020B2
A3C2	0180-1746	5		CAPACITOR-FXD 15UF+-10% 20VDC TA	56289	150D156X9020B2
A3C3	0180-1746	5		CAPACITOR-FXD 15UF+-10% 20VDC TA	56289	150D156X9020B2
A3C4	0160-2290	4		CAPACITOR-FXD .15UF +-10% 80VDC POLYE	28480	0160-2290
A3C5	0180-1745	4	1	CAPACITOR-FXD 1.5UF+-10% 20VDC TA	56289	150D155X9020A2
A3C6	0180-1746	5		CAPACITOR-FXD 15UF+-10% 20VDC TA	56289	150D156X9020B2
A3C7	0180-0291	3	3	CAPACITOR-FXD 1UF+-10% 35VDC TA	56289	150D105X9035A2
A3C8	0160-0168	1	1	CAPACITOR-FXD .1UF +-10% 200VDC POLYE	28480	0160-0168
A3C9	0160-0970	3	1	CAPACITOR-FXD .47UF +-10% 80VDC POLYE	28480	0160-0970
A3C10	0160-2055	9		CAPACITOR-FXD .01UF +80-20% 100VDC CER	28480	0160-2055
A3C11	0180-0218	4	1	CAPACITOR-FXD .15UF+-10% 35VDC TA	56289	150D154X9035A2
A3C12†	0160-5756	3	1	CAPACITOR-FXD .47UF +-5% 100VDC	28480	0160-5756
A3C13	0180-0374	3	1	CAPACITOR-FXD 10UF+-10% 20VDC TA	56289	150D106X9020B2
A3C14	0180-0291	3		CAPACITOR-FXD 1UF+-10% 35VDC TA	56289	150D105X9035A2
A3C15	0180-0291	3		CAPACITOR-FXD 1UF+-10% 35VDC TA	56289	150D105X9035A2
A3C16	0160-2290	4		CAPACITOR-FXD .15UF +-10% 80VDC POLYE	28480	0160-2290
A3C17	0180-1746	5		CAPACITOR-FXD 15UF+-10% 20VDC TA	56289	150D156X9020B2
A3C18- A3C22†				NOT ASSIGNED		
A3CR1	1901-0040	1		DIODE-SWITCHING 30V 50MA 2NS D0-35	28480	1901-0040
A3CR2	1901-0040	1		DIODE-SWITCHING 30V 50MA 2NS D0-35	28480	1901-0040
A3CR3	1901-0040	1		DIODE-SWITCHING 30V 50MA 2NS D0-35	28480	1901-0040
A3CR4	1901-0040	1		DIODE-SWITCHING 30V 50MA 2NS D0-35	28480	1901-0040
A3CR5	1901-0040	1		DIODE-SWITCHING 30V 50MA 2NS D0-35	28480	1901-0040
A3CR6	1901-0179	7	2	DIODE-SWITCHING 15V 50MA 750PS D0-7	28480	1901-0179
A3CR7	1901-0179	7		DIODE-SWITCHING 15V 50MA 750PS D0-7	28480	1901-0179
A3Q1	1853-0020	4		TRANSISTOR PNP SI PD=300MW FT=150MHZ	28480	1853-0020
A3Q2	1853-0020	4		TRANSISTOR PNP SI PD=300MW FT=150MHZ	28480	1853-0020
A3Q3	1853-0020	4		TRANSISTOR PNP SI PD=300MW FT=150MHZ	28480	1853-0020
A3Q4	1853-0020	4		TRANSISTOR PNP SI PD=300MW FT=150MHZ	28480	1853-0020
A3Q5	1853-0020	4		TRANSISTOR PNP SI PD=300MW FT=150MHZ	28480	1853-0020
A3Q6†	1854-0810	2		TRANSISTOR NPN SI PD=625MW FT=200MHZ	28480	1854-0810
A3Q7†	1854-0810	2		TRANSISTOR NPN SI PD=625MW FT=200MHZ	28480	1854-0810
A3Q8†	1854-0810	2		TRANSISTOR NPN SI PD=625MW FT=200MHZ	28480	1854-0810
A3Q9†	1854-0810	2		TRANSISTOR NPN SI PD=625MW FT=200MHZ	28480	1854-0810
A3Q10†	1854-0810	2		TRANSISTOR NPN SI PD=625MW FT=200MHZ	28480	1854-0810
A3Q11	1853-0020	4		TRANSISTOR PNP SI PD=300MW FT=150MHZ	28480	1853-0020
A3Q12†	1854-0810	2		TRANSISTOR NPN SI PD=625MW FT=200MHZ	28480	1854-0810
A3Q13	1855-0414	4		TRANSISTOR J-FET 2N4393 N-CHAN D-MODE	04713	2N4393
A3Q14	1855-0414	4		TRANSISTOR J-FET 2N4393 N-CHAN D-MODE	04713	2N4393
A3Q15	1855-0414	4		TRANSISTOR J-FET 2N4393 N-CHAN D-MODE	04713	2N4393
A3Q16	1855-0414	4		TRANSISTOR J-FET 2N4393 N-CHAN D-MODE	04713	2N4393
A3Q17†	1854-0810	2		TRANSISTOR NPN SI PD=625MW FT=200MHZ	28480	1854-0810
A3Q18	1855-0414	4		TRANSISTOR J-FET 2N4393 N-CHAN D-MODE	04713	2N4393
A3Q19	1855-0414	4		TRANSISTOR J-FET 2N4393 N-CHAN D-MODE	04713	2N4393
A3Q20	1855-0414	4		TRANSISTOR J-FET 2N4393 N-CHAN D-MODE	04713	2N4393
A3Q21†	1854-0810	2		TRANSISTOR NPN SI PD=625MW FT=200MHZ	28480	1854-0810
A3Q22	1853-0020	4		TRANSISTOR PNP SI PD=300MW FT=150MHZ	28480	1853-0020
A3Q23†	1854-0810	2		TRANSISTOR NPN SI PD=625MW FT=200MHZ	28480	1854-0810
A3Q24†	1854-0810	2		TRANSISTOR NPN SI PD=625MW FT=200MHZ	28480	1854-0810
A3Q25†	1854-0810	2		TRANSISTOR NPN SI PD=625MW FT=200MHZ	28480	1854-0810
A3Q26	1855-0414	4		TRANSISTOR J-FET 2N4393 N-CHAN D-MODE	04713	2N4393
A3Q27	1855-0414	4		TRANSISTOR J-FET 2N4393 N-CHAN D-MODE	04713	2N4393
A3Q28	1855-0414	4		TRANSISTOR J-FET 2N4393 N-CHAN D-MODE	04713	2N4393
A3Q29	1855-0414	4		TRANSISTOR J-FET 2N4393 N-CHAN D-MODE	04713	2N4393
A3Q30	1855-0414	4		TRANSISTOR J-FET 2N4393 N-CHAN D-MODE	04713	2N4393

See introduction to this section for ordering information  
 \*Indicates factory selected value  
 †Backdating information in Section VII

Table 6-2. Replaceable Parts

Reference Designation	HP Part Number	C D	Qty	Description	Mfr Code	Mfr Part Number
A3Q31	1855-0414	4		TRANSISTOR J-FET 2N4393 N-CHAN D-MODE	04713	2N4393
A3Q32	1855-0414	4		TRANSISTOR J-FET 2N4393 N-CHAN D-MODE	04713	2N4393
A3Q33	1855-0414	4		TRANSISTOR J-FET 2N4393 N-CHAN D-MODE	04713	2N4393
A3Q34†	1854-0810	2		TRANSISTOR NPN SI PD=625MW FT=200MHZ	28480	1854-0810
A3R1	0698-3157	3	7	RESISTOR 19.6K 1% .125W F TC=0+-100	24546	C4-1/8-T0-1962-F
A3R2	2100-2516	3	3	RESISTOR-TRMR 100K 10% C SIDE-ADJ 1-TRN	32997	3329W-1-104
A3R3	0757-0465	6		RESISTOR 100K 1% .125W F TC=0+-100	24546	C4-1/8-T0-1003-F
A3R4	0698-0085	0		RESISTOR 2.61K 1% .125W F TC=0+-100	24546	C4-1/8-T0-2611-F
A3R5	1810-0151	2		NETWORK-RES 7-SIP10.0K OHM X 6	91637	CSP07C07-103J
A3R6	0698-3157	3		RESISTOR 19.6K 1% .125W F TC=0+-100	24546	C4-1/8-T0-1962-F
A3R7	0757-0467	8	4	RESISTOR 121K 1% .125W F TC=0+-100	24546	C4-1/8-T0-1213-F
A3R8	0757-0467	8		RESISTOR 121K 1% .125W F TC=0+-100	24546	C4-1/8-T0-1213-F
A3R9	0757-0467	8		RESISTOR 121K 1% .125W F TC=0+-100	24546	C4-1/8-T0-1213-F
A3R10	0757-0462	3	3	RESISTOR 75K 1% .125W F TC=0+-100	24546	C4-1/8-T0-7502-F
A3R11	1810-0158	9		NETWORK-RES 7-SIP56.0K OHM X 6	28480	1810-0158
A3R12	0757-0442	9		RESISTOR 10K 1% .125W F TC=0+-100	24546	C4-1/8-T0-1002-F
A3R13	0757-0401	0		RESISTOR 100 1% .125W F TC=0+-100	24546	C4-1/8-T0-101-F
A3R14	0698-3157	3		RESISTOR 19.6K 1% .125W F TC=0+-100	24546	C4-1/8-T0-1962-F
A3R15	0757-0442	9		RESISTOR 10K 1% .125W F TC=0+-100	24546	C4-1/8-T0-1002-F
A3R16	0698-3136	8		RESISTOR 17.8K 1% .125W F TC=0+-100	24546	C4-1/8-T0-1782-F
A3R17	2100-2489	9	1	RESISTOR-TRMR 5K 10% C SIDE-ADJ 1-TRN	30983	ET50X502
A3R18	0698-3157	3		RESISTOR 19.6K 1% .125W F TC=0+-100	24546	C4-1/8-T0-1962-F
A3R19	0757-0442	9		RESISTOR 10K 1% .125W F TC=0+-100	24546	C4-1/8-T0-1002-F
A3R20	0698-3157	3		RESISTOR 19.6K 1% .125W F TC=0+-100	24546	C4-1/8-T0-1962-F
A3R21	0757-0442	9		RESISTOR 10K 1% .125W F TC=0+-100	24546	C4-1/8-T0-1002-F
A3R22	0757-0199	3	2	RESISTOR 21.5K 1% .125W F TC=0+-100	24546	C4-1/8-T0-2152-F
A3R23	0757-0462	3		RESISTOR 75K 1% .125W F TC=0+-100	24546	C4-1/8-T0-7502-F
A3R24	0698-3157	3		RESISTOR 19.6K 1% .125W F TC=0+-100	24546	C4-1/8-T0-1962-F
A3R25	0757-0442	9		RESISTOR 10K 1% .125W F TC=0+-100	24546	C4-1/8-T0-1002-F
A3R26	0757-0438	3		RESISTOR 5.11K 1% .125W F TC=0+-100	24546	C4-1/8-T0-5111-F
A3R27	0757-0401	0		RESISTOR 100 1% .125W F TC=0+-100	24546	C4-1/8-T0-101-F
A3R28	0757-0442	9		RESISTOR 10K 1% .125W F TC=0+-100	24546	C4-1/8-T0-1002-F
A3R29	0757-0458	7	2	RESISTOR 51.1K 1% .125W F TC=0+-100	24546	C4-1/8-T0-5112-F
A3R30	0698-3160	8		RESISTOR 31.6K 1% .125W F TC=0+-100	24546	C4-1/8-T0-3162-F
A3R31	0757-0442	9		RESISTOR 10K 1% .125W F TC=0+-100	24546	C4-1/8-T0-1002-F
A3R32	0698-3452	1		RESISTOR 147K 1% .125W F TC=0+-100	24546	C4-1/8-T0-1473-F
A3R33	0757-0421	4	1	RESISTOR 825 1% .125W F TC=0+-100	24546	C4-1/8-T0-825R-F
A3R34	0757-0442	9		RESISTOR 10K 1% .125W F TC=0+-100	24546	C4-1/8-T0-1002-F
A3R35	0698-3260	9	7	RESISTOR 464K 1% .125W F TC=0+-100	28480	0698-3260
A3R36	0757-0199	3		RESISTOR 21.5K 1% .125W F TC=0+-100	24546	C4-1/8-T0-2152-F
A3R37	2100-2522	1	1	RESISTOR-TRMR 10K 10% C SIDE-ADJ 1-TRN	30983	ET50X103
A3R38	0698-7666	7	1	RESISTOR 56K 1% .125W F TC=0+-25	19701	MF4C1/8-T9-5602-F
A3R39	0757-0280	3		RESISTOR 1K 1% .125W F TC=0+-100	24546	C4-1/8-T0-1001-F
A3R40	0698-3260	9		RESISTOR 464K 1% .125W F TC=0+-100	28480	0698-3260
A3R41	0757-0401	0		RESISTOR 100 1% .125W F TC=0+-100	24546	C4-1/8-T0-101-F
A3R42	0757-0458	7		RESISTOR 51.1K 1% .125W F TC=0+-100	24546	C4-1/8-T0-5112-F
A3R43	0698-3260	9		RESISTOR 464K 1% .125W F TC=0+-100	28480	0698-3260
A3R44	0757-0462	3		RESISTOR 75K 1% .125W F TC=0+-100	24546	C4-1/8-T0-7502-F
A3R45	0757-0180	2	1	RESISTOR 31.6 1% .125W F TC=0+-100	28480	0757-0180
A3R46	0698-3157	3		RESISTOR 19.6K 1% .125W F TC=0+-100	24546	C4-1/8-T0-1962-F
A3R47	2100-2516	3		RESISTOR-TRMR 100K 10% C SIDE-ADJ 1-TRN	32997	3329W-1-104
A3R48	2100-3207	1	1	RESISTOR-TRMR 5K 10% C SIDE-ADJ 1-TRN	28480	2100-3207
A3R49	0698-7880	7	2	RESISTOR 28.7K 1% .125W F TC=0+-25	19701	MF4C1/8-T9-2872-F
A3R50	0698-3260	9		RESISTOR 464K 1% .125W F TC=0+-100	28480	0698-3260
A3R51	0757-0465	6		RESISTOR 100K 1% .125W F TC=0+-100	24546	C4-1/8-T0-1003-F
A3R52	0698-3158	4		RESISTOR 23.7K 1% .125W F TC=0+-100	24546	C4-1/8-T0-2372-F
A3R53	0757-0401	0		RESISTOR 100 1% .125W F TC=0+-100	24546	C4-1/8-T0-101-F
A3R54	0757-0465	6		RESISTOR 100K 1% .125W F TC=0+-100	24546	C4-1/8-T0-1003-F
A3R55	0757-0460	1		RESISTOR 61.9K 1% .125W F TC=0+-100	24546	C4-1/8-T0-6192-F
A3R56	0698-3158	4		RESISTOR 23.7K 1% .125W F TC=0+-100	24546	C4-1/8-T0-2372-F
A3R57	0698-3444	1	1	RESISTOR 316 1% .125W F TC=0+-100	24546	C4-1/8-T0-316R-F
A3R58	0698-3160	8		RESISTOR 31.6K 1% .125W F TC=0+-100	24546	C4-1/8-T0-3162-F
A3R59	2100-3274	2	1	RESISTOR-TRMR 10K 10% C SIDE-ADJ 1-TRN	28480	2100-3274
A3R60	0757-0465	6		RESISTOR 100K 1% .125W F TC=0+-100	24546	C4-1/8-T0-1003-F

See introduction to this section for ordering information  
 \*Indicates factory selected value  
 †Backdating information in Section VII

Table 6-2. Replaceable Parts

Reference Designation	HP Part Number	C D	Qty	Description	Mfr Code	Mfr Part Number
A3R61	0757-0438	3		RESISTOR 5.11K 1% .125W F TC=0+-100	24546	C4-1/8-T0-5111-F
A3R62	0698-7880	7		RESISTOR 28.7K 1% .125W F TC=0+-25	19701	MF4C1/8-T9-2872-F
A3R63	0698-6799	5	1	RESISTOR 4.53K 1% .125W F TC=0+-25	28480	0698-6799
A3R64				NOT ASSIGNED		
A3R65	2100-2516	3		RESISTOR-TRMR 100K 10% C SIDE-ADJ 1-TRN	32997	3329W-1-104
A3R66	0698-0084	9		RESISTOR 2.15K 1% .125W F TC=0+-100	24546	C4-1/8-T0-2151-F
A3R67	0757-0289	2		RESISTOR 13.3K 1% .125W F TC=0+-100	19701	MF4C1/8-T0-1332-F
A3R68	0757-0467	8		RESISTOR 121K 1% .125W F TC=0+-100	24546	C4-1/8-T0-1213-F
A3R69	0757-0280	3		RESISTOR 1K 1% .125W F TC=0+-100	24546	C4-1/8-T0-1001-F
A3R70	0698-3440	7	1	RESISTOR 196 1% .125W F TC=0+-100	24546	C4-1/8-T0-196R-F
A3R71	0757-0420	3	1	RESISTOR 750 1% .125W F TC=0+-100	24546	C4-1/8-T0-751-F
A3R72	0757-0401	0		RESISTOR 100 1% .125W F TC=0+-100	24546	C4-1/8-T0-101-F
A3TP1	0360-1514	7		TERMINAL-STUD SGL-PIN PRESS-MTG	28480	0360-1514
A3TP2	0360-1514	7		TERMINAL-STUD SGL-PIN PRESS-MTG	28480	0360-1514
A3TP3	0360-1514	7		TERMINAL-STUD SGL-PIN PRESS-MTG	28480	0360-1514
A3TP4	0360-1514	7		TERMINAL-STUD SGL-PIN PRESS-MTG	28480	0360-1514
A3TP5	0360-1514	7		TERMINAL-STUD SGL-PIN PRESS-MTG	28480	0360-1514
A3TP6	0360-1514	7		TERMINAL-STUD SGL-PIN PRESS-MTG	28480	0360-1514
A3U1	1826-0102	6	2	IC OP AMP LOW-BIAS-H-IMPD TO-99 PKG	27014	LM312H
A3U2	1820-0223	0		IC OP AMP GP TO-99 PKG	3L585	CA301AT
A3U3	1826-0102	6		IC OP AMP LOW-BIAS-H-IMPD TO-99 PKG	27014	LM312H
A3U4	1826-0547	3	2	IC OP AMP LOW-BIAS-H-IMPD DUAL 8-DIP-P	01295	TL072ACP
A3U5	1826-0547	3		IC OP AMP LOW-BIAS-H-IMPD DUAL 8-DIP-P	01295	TL072ACP
A3VR1	1902-0041	4	1	DIODE-ZNR 5.11V 5% D0-35 PD=.4W	28480	1902-0041
A3VR2	1902-0680	7	1	DIODE-ZNR 1N827 6.2V 5% D0-7 PD=.4W	24046	1N827
A3VR3	1902-3024	9	1	DIODE-ZNR 2.87V 5% D0-7 PD=.4W TC=-.07%	28480	1902-3024
A3VR4	1902-3139	7	2	DIODE-ZNR 8.25V 5% D0-35 PD=.4W	28480	1902-3139
A3VR5	1902-3139	7		DIODE-ZNR 8.25V 5% D0-35 PD=.4W	28480	1902-3139
A3VR6	1902-3070	5	2	DIODE-ZNR 4.22V 5% D0-35 PD=.4W	28480	1902-3070
				A3 MISCELLANEOUS PARTS		
	5000-9043	6		PIN:P.C. BOARD EXTRACTOR	28480	5000-9043
	5040-6852	3	1	EXTRACTOR, ORANGE	28480	5040-6852
A4	00436-60003	1	1	COUNTER ASSEMBLY	28480	00436-60003
A4C1	0180-0197	8		CAPACITOR-FXD 2.2UF+-10% 20VDC TA	56289	150D225X9020A2
A4C2	0160-2055	9		CAPACITOR-FXD .01UF +80-20% 100VDC CER	28480	0160-2055
A4C3	0160-2055	9		CAPACITOR-FXD .01UF +80-20% 100VDC CER	28480	0160-2055
A4C4	0160-2055	9		CAPACITOR-FXD .01UF +80-20% 100VDC CER	28480	0160-2055
A4C5	0160-2055	9		CAPACITOR-FXD .01UF +80-20% 100VDC CER	28480	0160-2055
A4C6	0160-2055	9		CAPACITOR-FXD .01UF +80-20% 100VDC CER	28480	0160-2055
A4C7	0160-2055	9		CAPACITOR-FXD .01UF +80-20% 100VDC CER	28480	0160-2055
A4C8	0160-2055	9		CAPACITOR-FXD .01UF +80-20% 100VDC CER	28480	0160-2055
A4C9	0160-3456	6	2	CAPACITOR-FXD 1000PF +-10% 1KVDC CER	28480	0160-3456
A4C10	0160-3456	6		CAPACITOR-FXD 1000PF +-10% 1KVDC CER	28480	0160-3456
A4J1	1200-0507	9	1	SOCKET-IC 16-CONT DIP-SLDR	28480	1200-0507
A4Q1†	1854-0810	2		TRANSISTOR NPN SI PD=625MW FT=200MHZ	28480	1854-0810
A4R1	0757-0442	9		RESISTOR 10K 1% .125W F TC=0+-100	24546	C4-1/8-T0-1002-F
A4R2	0757-0442	9		RESISTOR 10K 1% .125W F TC=0+-100	24546	C4-1/8-T0-1002-F
A4R3	0757-0442	9		RESISTOR 10K 1% .125W F TC=0+-100	24546	C4-1/8-T0-1002-F
A4R4	0757-0442	9		RESISTOR 10K 1% .125W F TC=0+-100	24546	C4-1/8-T0-1002-F
A4R5	0698-3260	9		RESISTOR 464K 1% .125W F TC=0+-100	28480	0698-3260
A4R6†	0698-0084	9	4	RESISTOR 2.15K 1% .125W F TC=0+-100	24546	C4-1/8-T0-2151-F
A4TP1	0360-1514	7		TERMINAL-STUD SGL-PIN PRESS-MTG	28480	0360-1514
A4TP2	0360-1514	7		TERMINAL-STUD SGL-PIN PRESS-MTG	28480	0360-1514
A4TP3	0360-1514	7		TERMINAL-STUD SGL-PIN PRESS-MTG	28480	0360-1514
A4U1	1820-1411	0	5	IC LCH TTL LS D-TYPE 4-BIT	01295	SN74LS75N
A4U2	1820-1411	0		IC LCH TTL LS D-TYPE 4-BIT	01295	SN74LS75N
A4U3	1820-1411	0		IC LCH TTL LS D-TYPE 4-BIT	01295	SN74LS75N
A4U4	1820-1411	0		IC LCH TTL LS D-TYPE 4-BIT	01295	SN74LS75N
A4U5†	1820-1277	6	8	IC CNTR TTL LS DECD UP/DOWN SYNCHRO	01295	SN74LS192N

See introduction to this section for ordering information

\*Indicates factory selected value

†Backdating information in Section VII

Table 6-2. Replaceable Parts

Reference Designation	HP Part Number	C D	Qty	Description	Mfr Code	Mfr Part Number
A4U6†	1820-1277	6		IC CNTR TTL LS DECD UP/DOWN SYNCHRO	01295	SN74LS192N
A4U7†	1820-1277	6		IC CNTR TTL LS DECD UP/DOWN SYNCHRO	01295	SN74LS192N
A4U8†	1820-1277	6		IC CNTR TTL LS DECD UP/DOWN SYNCHRO	01295	SN74LS192N
A4U9†	1820-1277	6		IC CNTR TTL LS DECD UP/DOWN SYNCHRO	01295	SN74LS192N
A4U10†	1820-1277	6		IC CNTR TTL LS DECD UP/DOWN SYNCHRO	01295	SN74LS192N
A4U11†	1820-1277	6		IC CNTR TTL LS DECD UP/DOWN SYNCHRO	01295	SN74LS192N
A4U12†	1820-1277	6		IC CNTR TTL LS DECD UP/DOWN SYNCHRO	01295	SN74LS192N
A4U13	1820-1202	7	2	IC GATE TTL LS NAND TPL 3-INP	01295	SN74LS10N
A4U14	1820-1197	9	4	IC GATE TTL LS NAND QUAD 2-INP	01295	SN74LS00N
A4U15	1820-1212	9	1	IC FF TTL LS J-K NEG-EDGE-TRIG	01295	SN74LS112AN
A4U16	1820-0077	2	1	IC FF TTL D-TYPE POS-EDGE-TRIG CLEAR	01295	SN7474N
A4U17	1820-0076	1	1	IC FF TTL J-K PULSE PRESET/CLEAR DUAL	01295	SN7476N
A4U18	1820-1197	9		IC GATE TTL LS NAND QUAD 2-INP	01295	SN74LS00N
A4U19	1820-1197	9		IC GATE TTL LS NAND QUAD 2-INP	01295	SN74LS00N
A4U20	1820-1204	9	1	IC GATE TTL LS NAND DUAL 4-INP	01295	SN74LS20N
A4U21	1820-1199	1	2	IC INV TTL LS HEX 1-INP	01295	SN74LS04N
A4Y1	0410-0590	4	1	CRYSTAL-QUARTZ 240.000 KHZ	28480	0410-0590
				A4 MISCELLANEOUS PARTS		
	5000-9043	6		PIN:P.C. BOARD EXTRACTOR	28480	5000-9043
	5040-6848	7	1	EXTRACTOR	28480	5040-6848
A5	00436-60004	2	1	CONTROLLER ASSEMBLY	28480	00436-60004
ASC1	0180-0197	8		CAPACITOR-FXD 2.2UF+-10% 20VDC TA	56289	150D225X9020A2
ASC2	0180-0100	3	1	CAPACITOR-FXD 4.7UF+-10% 35VDC TA	56289	150D475X9035B2
ASC3	0160-2055	9		CAPACITOR-FXD .01UF +80-20% 100VDC CER	28480	0160-2055
ASC4	0160-2055	9		CAPACITOR-FXD .01UF +80-20% 100VDC CER	28480	0160-2055
ASC5	0180-2206	4		CAPACITOR-FXD 60UF+-10% 6VDC TA	56289	150D606X9006B2
ASCR1	1901-0040	1		DIODE-SWITCHING 30V 50MA 2NS DO-35	28480	1901-0040
ASQ1†	1854-0810	2		TRANSISTOR NPN SI PD=625MW FT=200MHZ	28480	1854-0810
ASQ2†	1854-0810	2		TRANSISTOR NPN SI PD=625MW FT=200MHZ	28480	1854-0810
ASQ3†	1854-0810	2		TRANSISTOR NPN SI PD=625MW FT=200MHZ	28480	1854-0810
ASQ4†	1854-0810	2		TRANSISTOR NPN SI PD=625MW FT=200MHZ	28480	1854-0810
ASQ5†	1854-0810	2		TRANSISTOR NPN SI PD=625MW FT=200MHZ	28480	1854-0810
ASQ6	1853-0020	4		TRANSISTOR PNP SI PD=300MW FT=150MHZ	28480	1853-0020
ASR1	0698-0082	7	1	RESISTOR 464 1% .125W F TC=0+-100	24546	C4-1/8-T0-4640-F
ASR2	0698-3439	4	1	RESISTOR 178 1% .125W F TC=0+-100	24546	C4-1/8-T0-178R-F
ASR3	1810-0151	2		NETWORK-RES 7-SIP10.0K OHM X 6	91637	CSP07C07-103J
ASR4	1810-0151	2		NETWORK-RES 7-SIP10.0K OHM X 6	91637	CSP07C07-103J
ASR5	0698-3260	9		RESISTOR 464K 1% .125W F TC=0+-100	28480	0698-3260
ASR6	0698-3260	9		RESISTOR 464K 1% .125W F TC=0+-100	28480	0698-3260
ASR7	0683-4755	8	1	RESISTOR 4.7M 5% .25W FC TC=-900/+1100	01121	CB4755
ASR8	1810-0151	2		NETWORK-RES 7-SIP10.0K OHM X 6	91637	CSP07C07-103J
ASR9	0757-0438	3		RESISTOR 5.11K 1% .125W F TC=0+-100	24546	C4-1/8-T0-5111-F
ASR10	0757-0442	9		RESISTOR 10K 1% .125W F TC=0+-100	24546	C4-1/8-T0-1002-F
ASR11	1810-0151	2		NETWORK-RES 7-SIP10.0K OHM X 6	91637	CSP07C07-103J
ASR12	1810-0151	2		NETWORK-RES 7-SIP10.0K OHM X 6	91637	CSP07C07-103J
ASR13	1810-0151	2		NETWORK-RES 7-SIP10.0K OHM X 6	91637	CSP07C07-103J
ASR14	0757-0460	1		RESISTOR 61.9K 1% .125W F TC=0+-100	24546	C4-1/8-T0-6192-F
ASR15	0757-0442	9		RESISTOR 10K 1% .125W F TC=0+-100	24546	C4-1/8-T0-1002-F
ASR16	0698-3160	8		RESISTOR 31.6K 1% .125W F TC=0+-100	24546	C4-1/8-T0-3162-F
ASR17	0757-0280	3		RESISTOR 1K 1% .125W F TC=0+-100	24546	C4-1/8-T0-1001-F
ASR18	0698-3159	5		RESISTOR 26.1K 1% .125W F TC=0+-100	24546	C4-1/8-T0-2612-F
ASR19	0757-0290	5		RESISTOR 6.19K 1% .125W F TC=0+-100	19701	MF4C1/8-T0-6191-F
ASR20	0757-0442	9		RESISTOR 10K 1% .125W F TC=0+-100	24546	C4-1/8-T0-1002-F
ASR21	0757-0444	1		RESISTOR 12.1K 1% .125W F TC=0+-100	24546	C4-1/8-T0-1212-F
ASR22	0757-0444	1		RESISTOR 12.1K 1% .125W F TC=0+-100	24546	C4-1/8-T0-1212-F
ASU1	1820-1112	8	5	IC FF TTL LS D-TYPE POS-EDGE-TRIG	01295	SN74LS74AN
ASU2	1820-1112	8		IC FF TTL LS D-TYPE POS-EDGE-TRIG	01295	SN74LS74AN
ASU3	1820-1112	8		IC FF TTL LS D-TYPE POS-EDGE-TRIG	01295	SN74LS74AN
ASU4	1820-1112	8		IC FF TTL LS D-TYPE POS-EDGE-TRIG	01295	SN74LS74AN
ASU5	1820-0054	5	2	IC GATE TTL NAND QUAD 2-INP	01295	SN7400N

See introduction to this section for ordering information  
 \*Indicates factory selected value  
 †Backdating information in Section VII

Table 6-2. Replaceable Parts

Reference Designation	HP Part Number	C D	Qty	Description	Mfr Code	Mfr Part Number
ASU6	1820-0328	6	1	IC GATE TTL NOR QUAD 2-INP	01295	SN7402N
ASU7	1820-1194	6	1	IC CNTR TTL LS BIN UP/DOWN SYNCHRO	01295	SN74LS193N
ASU8	1820-1112	8		IC FF TTL LS D-TYPE POS-EDGE-TRIG	01295	SN74LS74AN
ASU9	1820-1411	0		IC LCH TTL LS D-TYPE 4-BIT	01295	SN74LS75N
ASU10	1820-0175	1		IC INV TTL HEX 1-INP	01295	SN7405N
ASU11	1818-2244	4	1	IC NMOS 4096 (4K) ROM	28480	1818-2244
ASU12	1820-1199	1		IC INV TTL LS HEX 1-INP	01295	SN74LS04N
ASU13	1820-0640	5	1	IC MUXR/DATA-SEL TTL 16-T0-1-LINE 16-INP	01295	SN74150N
ASU14	1820-0495	8	1	IC DCOR TTL 4-T0-16-LINE 4-INP	01295	SN74154N
ASU15	1820-1197	9		IC GATE TTL LS NAND QUAD 2-INP	01295	SN74LS00N
ASU16	1820-1202	7		IC GATE TTL LS NAND TPL 3-INP	01295	SN74LS10N
ASU17	1820-0054	5		IC GATE TTL NAND QUAD 2-INP	01295	SN7400N
ASVR1	1902-3070	5		DIODE-ZNR 4.22V 5% D0-3S PD=.4W	28480	1902-3070
ASXU11†	1200-0567	1	1	SOCKET-IC 28-CONT DIP DIP-SLDR	28480	1200-0567
				AS MISCELLANEOUS PARTS		
	5000-9043	6		PIN:P.C. BOARD EXTRACTOR	28480	5000-9043
	5040-6851	2	1	EXTRACTOR	28480	5040-6851

See introduction to this section for ordering information

\*Indicates factory selected value

†Backdating information in Section VII

Table 6-2. Replaceable Parts

Reference Designation	HP Part Number	C D	Qty	Description	Mfr Code	Mfr Part Number
A6†	00436-60053	1	1	HP INTERFACE BUS (HP-IB) CONTROL ASSEMBL (FOR OPTION 022 ONLY)	28480	00436-60053
A6C1	0180-0197	8	2	CAPACITOR-FXD 2.2UF +-10% 20VDC TA	56289	1500225X9020A2
A6C2	0160-3334	9	10	CAPACITOR-FXD .01UF +-10% 50VDC CER	28480	0160-3334
A6C3	0160-3334	9		CAPACITOR-FXD .01UF +-10% 50VDC CER	28480	0160-3334
A6C4	0160-3334	9		CAPACITOR-FXD .01UF +-10% 50VDC CER	28480	0160-3334
A6C5	0160-3334	9		CAPACITOR-FXD .01UF +-10% 50VDC CER	28480	0160-3334
A6C6	0160-3334	9		CAPACITOR-FXD .01UF +-10% 50VDC CER	28480	0160-3334
A6C7	0160-4574	1	4	CAPACITOR-FXD 1000PF +-10% 100VDC CER	28480	0160-4574
A6C8	0160-3334	9		CAPACITOR-FXD .01UF +-10% 50VDC CER	28480	0160-3334
A6C9	0160-3334	9		CAPACITOR-FXD .01UF +-10% 50VDC CER	28480	0160-3334
A6C10	0160-3334	9		CAPACITOR-FXD .01UF +-10% 50VDC CER	28480	0160-3334
A6C11	0160-3334	9		CAPACITOR-FXD .01UF +-10% 50VDC CER	28480	0160-3334
A6C12	0160-3334	9		CAPACITOR-FXD .01UF +-10% 50VDC CER	28480	0160-3334
A6C13	0160-4574	1		CAPACITOR-FXD 1000PF +-10% 100VDC CER	28480	0160-4574
A6C14	0160-4918	7	3	CAPACITOR-FXD .022UF +-10% 50VDC CER	28480	0160-4918
A6C15	0160-4918	7		CAPACITOR-FXD .022UF +-10% 50VDC CER	28480	0160-4918
A6C16	0160-4918	7		CAPACITOR-FXD .022UF +-10% 50VDC CER	28480	0160-4918
A6C17	0160-4574	1		CAPACITOR-FXD 1000PF +-10% 100VDC CER	28480	0160-4574
A6C18	0160-4574	1		CAPACITOR-FXD 1000PF +-10% 100VDC CER	28480	0160-4574
A6CR1	1901-0040	1	1	DIODE-SWITCHING 30V 50MA 2NS D0-35	28480	1901-0040
A6Q1	1853-0020	4	1	TRANSISTOR PNP SI PD=300MW FT=150MHZ	28480	1853-0020
A6R1	0698-3444	1	6	RESISTOR 316 1% .125W F TC=0+-100	24546	C4-1/8-T0-316R-F
A6R2	0757-0280	3	1	RESISTOR 1K 1% .125W F TC=0+-100	24546	C4-1/8-T0-1001-F
A6R3	0698-3444	1		RESISTOR 316 1% .125W F TC=0+-100	24546	C4-1/8-T0-316R-F
A6R4	0698-3444	1		RESISTOR 316 1% .125W F TC=0+-100	24546	C4-1/8-T0-316R-F
A6R5	0757-0442	9	7	RESISTOR 10K 1% .125W F TC=0+-100	24546	C4-1/8-T0-1002-F
A6R6	0698-3444	1		RESISTOR 316 1% .125W F TC=0+-100	24546	C4-1/8-T0-316R-F
A6R7	0698-3444	1		RESISTOR 316 1% .125W F TC=0+-100	24546	C4-1/8-T0-316R-F
A6R8	0698-3444	1		RESISTOR 316 1% .125W F TC=0+-100	24546	C4-1/8-T0-316R-F
A6R9	0757-0442	9		RESISTOR 10K 1% .125W F TC=0+-100	24546	C4-1/8-T0-1002-F
A6R10	0757-0442	9		RESISTOR 10K 1% .125W F TC=0+-100	24546	C4-1/8-T0-1002-F
A6R11	0757-0442	9		RESISTOR 10K 1% .125W F TC=0+-100	24546	C4-1/8-T0-1002-F
A6S1†	3101-0403	6	1	SWITCH-SL 5-SPOT DIP-SLIDE-ASSY .1A	28480	3101-0403
A6TP1	0360-1514	7	4	TERMINAL-STUD SGL-PIN PRESS-MTG	28480	0360-1514
A6TP2	0360-1514	7		TERMINAL-STUD SGL-PIN PRESS-MTG	28480	0360-1514
A6TP3	0360-1514	7		TERMINAL-STUD SGL-PIN PRESS-MTG	28480	0360-1514
A6TP4	0360-1514	7		TERMINAL-STUD SGL-PIN PRESS-MTG	28480	0360-1514
A6U1	1820-1204	9	1	IC GATE TTL LS NAND DUAL 4-INP	01295	SN74LS20N
A6U2	1820-1144	6	3	IC GATE TTL LS NOR QUAD 2-INP	01295	SN74LS02N
A6U3	1820-1197	9	3	IC GATE TTL LS NAND QUAD 2-INP	01295	SN74LS00N
A6U4	1820-1207	2	1	IC GATE TTL LS NAND 8-INP	01295	SN74LS30N
A6U5	1820-1112	8	5	IC FF TTL LS D-TYPE POS-EDGE-TRIG	01295	SN74LS74AN
A6U6	1820-1112	8		IC FF TTL LS D-TYPE POS-EDGE-TRIG	01295	SN74LS74AN
A6U7	1820-1144	6		IC GATE TTL LS NOR QUAD 2-INP	01295	SN74LS02N
A6U8	1820-1112	8		IC FF TTL LS D-TYPE POS-EDGE-TRIG	01295	SN74LS74AN
A6U9	1820-1053	6	2	IC SCHMITT-TRIG TTL INV HEX	01295	SN7414N
A6U10	1820-1199	1	2	IC INV TTL LS HEX 1-INP	01295	SN74LS04N
A6U11	1820-1202	7	2	IC GATE TTL LS NAND TPL 3-INP	01295	SN74LS10N
A6U12	1820-0621	2	3	IC BFR TTL NAND QUAD 2-INP	01295	SN7438N
A6U13	1820-1197	9		IC GATE TTL LS NAND QUAD 2-INP	01295	SN74LS00N
A6U14	1820-0629	0	1	IC FF TTL S J-K NEG-EDGE-TRIG	01295	SN74S112N
A6U15	1820-1298	1	5	IC MUXR/DATA-SEL TTL LS 8-TO-1-LINE	01295	SN74LS251N
A6U16	1820-1198	0	3	IC GATE TTL LS NAND QUAD 2-INP	01295	SN74LS03N
A6U17	1820-1112	8		IC FF TTL LS D-TYPE POS-EDGE-TRIG	01295	SN74LS74AN
A6U18	1820-1053	6		IC SCHMITT-TRIG TTL INV HEX	01295	SN7414N
A6U19	1820-1199	1		IC INV TTL LS HEX 1-INP	01295	SN74LS04N
A6U20	1820-1197	9		IC GATE TTL LS NAND QUAD 2-INP	01295	SN74LS00N

See introduction to this section for ordering information  
 †Indicates factory selected value  
 †Backdating information in Section VII

Table 6-2. Replaceable Parts

Reference Designation	HP Part Number	C D	Qty	Description	Mfr Code	Mfr Part Number
A6U21	1820-1144	6		IC GATE TTL LS NOR QUAD 2-INP	01295	SN74LS02N
A6U22	1820-1056	9	1	IC SCHMITT-TRIG TTL NAND QUAD 2-INP	01295	SN74132N
A6U23	1820-1216	3	1	IC DCDR TTL LS 3-TO-8-LINE 3-INP	01295	SN74LS138N
A6U24	1820-1202	7		IC GATE TTL LS NAND TPL 3-INP	01295	SN74LS10N
A6U25	1820-1112	8		IC FF TTL LS D-TYPE POS-EDGE-TRIG	01295	SN74LS74AN
A6U26	1820-1198	0		IC GATE TTL LS NAND QUAD 2-INP	01295	SN74LS03N
A6XA1- A6XA6 A6XA7	1251-2315	8	1	NOT ASSIGNED CONNECTOR-PC EDGE 20-CONT/ROW 2-ROWS  A6 MISCELLANEOUS (OPT. 022)	28480	1251-2315
	5000-9043	6	1	PIN:P.C. BOARD EXTRACTOR	28480	5000-9043
	5040-6849	8	1	EXTRACTOR, P.C. BOARD	28480	5040-6849
A7	00436-60012	2	1	HP INTERFACE BUS(HP-IB)INPUT/OUTPUT ASS (FOR OPTION 022 ONLY)	28480	00436-60012
A7C1	0180-0197	8		CAPACITOR-FXD 2.2UF+-10% 20VDC TA	56289	150D225X9020A2
A7C2	0160-3879	7	2	CAPACITOR-FXD .01UF +-20% 100VDC CER	28480	0160-3879
A7C3	0160-3879	7		CAPACITOR-FXD .01UF +-20% 100VDC CER	28480	0160-3879
A7J1	1200-0507	9	1	SOCKET-IC 16-CONT DIP-SLDR	28480	1200-0507
A7J2				NOT ASSIGNED		
A7J3				NOT ASSIGNED		
A7J4				NOT ASSIGNED		
A7J5				NOT ASSIGNED		
A7J6				NOT ASSIGNED		
A7J7	1251-3283	1	1	CONNECTOR 24-PIN F MICRORIBBON	28480	1251-3283
A7Q1*	1854-0810	2	1	TRANSISTOR NPN SI PD=625MW FT=200MHZ	28480	1854-0810
A7R1	1810-0151	2	2	NETWORK-RES 7-SIP10.0K OHM X 6	91637	CSP07C07-103J
A7R2	1810-0151	2		NETWORK-RES 7-SIP10.0K OHM X 6	91637	CSP07C07-103J
A7R3	1810-0136	3	2	NETWORK-RES 10-SIP MULTI-VALUE	28480	1810-0136
A7R4	0757-0442	9		RESISTOR 10K 1% .125W F TC=0+-100	24546	C4-1/8-T0-1002-F
A7R5	0757-0442	9		RESISTOR 10K 1% .125W F TC=0+-100	24546	C4-1/8-T0-1002-F
A7R6	0757-0442	9		RESISTOR 10K 1% .125W F TC=0+-100	24546	C4-1/8-T0-1002-F
A7R7	1810-0136	3		NETWORK-RES 10-SIP MULTI-VALUE	28480	1810-0136
A7S1	3101-1213	8	1	SWITCH-TGL SUBMIN DPST .5A 120VAC PC	28480	3101-1213
A7U1	1820-1298	1		IC MUXR/DATA-SEL TTL LS 8-TO-1-LINE	01295	SN74LS251N
A7U2	1820-1194	6	1	IC CNTR TTL LS BIN UP/DOWN SYNCHRO	01295	SN74LS193N
A7U3	1820-1298	1		IC MUXR/DATA-SEL TTL LS 8-TO-1-LINE	01295	SN74LS251N
A7U4†	00436-80008	8	1	IC TTL S 256-BIT ROM 40-NS 3-S	28480	00436-80008
A7U5	1820-0621	2		IC BFR TTL NAND QUAD 2-INP	01295	SN7438N
A7U6	1820-1298	1		IC MUXR/DATA-SEL TTL LS 8-TO-1-LINE	01295	SN74LS251N
A7U7	1820-1198	0		IC GATE TTL LS NAND QUAD 2-INP	01295	SN74LS03N
A7U8	1820-0621	2		IC BFR TTL NAND QUAD 2-INP	01295	SN7438N
A7U9	1820-1298	1		IC MUXR/DATA-SEL TTL LS 8-TO-1-LINE	01295	SN74LS251N
				A7 MISCELLANEOUS (OPT. 022)		
	0380-0643	3	2	STANDOFF-HEX .255-IN-LG 6-32THD	00000	ORDER BY DESCRIPTION
	1530-1098	4	2	CLEVIS 0.070-IN W SLT: 0.454-IN PIN CTR	00000	ORDER BY DESCRIPTION
	00436-00010	4	1	COVER PLATE-HP-IB	28480	00436-00010
	5951-7587	4	1	TAG-HARDWARE	28480	5951-7587
	7120-4855	4	1	LABEL-IDENTIFICATION .45-IN-WD 1.5-IN-LG (OPTION 022)	28480	7120-4855

See introduction to this section for ordering information

\*Indicates factory selected value

†Backdating information in Section VII

Table 6-2. Replaceable Parts

Reference Designation	HP Part Number	C D	Qty	Description	Mfr Code	Mfr Part Number
<p>The A6 and A7 assemblies for Option 024 have been deleted.</p>						

See introduction to this section for ordering information  
\*Indicates factory selected value  
†Backdating information in Section VII



Table 6-2. Replaceable Parts

Reference Designation	HP Part Number	C D	Qty	Description	Mfr Code	Mfr Part Number
A8	00436-60030	4	1	POWER REFERENCE OSCILLATOR ASSEMBLY	28480	00436-60030
A8A1	00436-60011	1	1	POWER REFERENCE OSCILLATOR BOARD ASSEMBLY	28480	00436-60011
A8A1C1	0160-3879	7	4	CAPACITOR-FXD .01UF +-20% 100VDC CER	28480	0160-3879
A8A1C2	0160-3036	8	2	CAPACITOR-FDTHRU 5000PF +80 -20% 200V	28480	0160-3036
A8A1C3	0160-3036	8		CAPACITOR-FDTHRU 5000PF +80 -20% 200V	28480	0160-3036
A8A1C4	0160-3879	7		CAPACITOR-FXD .01UF +-20% 100VDC CER	28480	0160-3879
A8A1C5	0160-3879	7		CAPACITOR-FXD .01UF +-20% 100VDC CER	28480	0160-3879
A8A1C6	0160-2027	5	1	CAPACITOR-FXD 300PF +-5% 500VDC MICA	28480	0160-2027
A8A1C7	0160-3070	0	1	CAPACITOR-FXD 100PF +-5% 300VDC MICA	28480	0160-3070
A8A1C8	0180-0100	3	1	CAPACITOR-FXD 4.7UF+-10% 35VDC TA	56289	150D475X9035B2
A8A1C9	0160-2255	1	1	CAPACITOR-FXD 8.2PF +- .25PF 500VDC CER	28480	0160-2255
A8A1C10	0160-3878	6	1	CAPACITOR-FXD 1000PF +-20% 100VDC CER	28480	0160-3878
A8A1C11	0160-0179	4	1	CAPACITOR-FXD 33PF +-5% 300VDC MICA	28480	0160-0179
A8A1C12	0160-3879	7		CAPACITOR-FXD .01UF +-20% 100VDC CER	28480	0160-3879
A8A1C13	0160-4006	4	1	CAPACITOR-FXD 36PF +-5% 300VDC GL	28480	0160-4006
A8A1C14	0160-4007	5	1	CAPACITOR-FXD 200PF +-5% 300VDC GL	28480	0160-4007
A8A1CR1	1901-0518	8	2	DIODE-SM SIG SCHOTTKY	28480	1901-0518
A8A1CR2	1901-0518	8		DIODE-SM SIG SCHOTTKY	28480	1901-0518
A8A1CR3	0122-0299	9	1	DIODE-VVC 82PF 5% C2/C20-MIN=2 BVR=20V	28480	0122-0299
A8A1J1	1250-1220	0	1	CONNECTOR-RF SMC M PC 50-OHM	28480	1250-1220
A8A1L1	00436-80001	1	1	COIL-VARIABLE	28480	00436-80001
A8A1L2	9140-0144	0	1	INDUCTOR RF-CH-MLD 4.7UH 10% .105DX.26LG	28480	9140-0144
A8A1L3	00436-80002	2	1	COIL-3-1/2 TURNS	28480	00436-80002
A8A1Q1	1854-0247	9	1	TRANSISTOR NPN SI T0-39 PD=1W FT=800MHZ	28480	1854-0247
A8A1Q2†	1854-0810	2	1	TRANSISTOR NPN SI PD=625MW FT=200MHZ	28480	1854-0810
A8A1R1	0757-0442	9	2	RESISTOR 10K 1% .125W F TC=0+-100	24546	C4-1/8-T0-1002-F
A8A1R2*	0757-1094	9	1	RESISTOR 1.47K 1% .125W F TC=0+-100	24546	C4-1/8-T0-1471-F
A8A1R3	0811-3234	9	1	RESISTOR 10K 1% .05W PWJ TC=0+-10	20940	140-1/20-1002-F
A8A1R4	2100-3154	7	1	RESISTOR-TRMR 1K 10% C SIDE-ADJ 17-TRN	02111	43P102
A8A1R5	0811-3381	7	1	RESISTOR 7.1K 1% .05W PWJ TC=0+-10	28480	0811-3381
A8A1R6	0757-0440	7	1	RESISTOR 7.5K 1% .125W F TC=0+-100	24546	C4-1/8-T0-7501-F
A8A1R7	0698-7284	5	2	RESISTOR 100K 1% .05W F TC=0+-100	24546	C3-1/8-T0-1003-F
A8A1R8	0757-0465	6	1	RESISTOR 100K 1% .125W F TC=0+-100	24546	C4-1/8-T0-1003-F
A8A1R9	0698-7284	5		RESISTOR 100K 1% .05W F TC=0+-100	24546	C3-1/8-T0-1003-F
A8A1R10	0757-0280	3	2	RESISTOR 1K 1% .125W F TC=0+-100	24546	C4-1/8-T0-1001-F
A8A1R11	0757-0280	3		RESISTOR 1K 1% .125W F TC=0+-100	24546	C4-1/8-T0-1001-F
A8A1R12	0757-0442	9		RESISTOR 10K 1% .125W F TC=0+-100	24546	C4-1/8-T0-1002-F
A8A1R13	0757-0438	3	1	RESISTOR 5.11K 1% .125W F TC=0+-100	24546	C4-1/8-T0-5111-F
A8A1R14	0757-0398	4	1	RESISTOR 75 1% .125W F TC=0+-100	24546	C4-1/8-T0-75R0-F
A8A1R15	0757-0317	7	1	RESISTOR 1.33K 1% .125W F TC=0+-100	24546	C4-1/8-T0-1331-F
A8A1R16†	0698-6364	0	1	RESISTOR 50 .1% .125W F TC=0+-25	28480	0698-6364
A8A1TP1	0360-1514	7	8	TERMINAL-STUD SGL-PIN PRESS-MTG	28480	0360-1514
A8A1TP2	0360-1514	7		TERMINAL-STUD SGL-PIN PRESS-MTG	28480	0360-1514
A8A1U1	1826-0013	8	1	IC OP AMP LOW-NOISE T0-99 PKG	06665	SSS741CJ
A8A1U2	1820-0223	0	1	IC OP AMP GP T0-99 PKG	3L585	CA301AT
A8A1VR1	1902-0680	7	1	DIODE-ZNR 1N827 6.2V 5% D0-7 PD=.4W	24046	1N827
A8A1VR2*	1902-0956	0	1	DIODE-ZNR 8.2V 5% D0-35 PD=.4W TC=+.065%	28480	1902-0956
A8 MISCELLANEOUS PARTS						
	2190-0008	3	4	WASHER-LK EXT T NO. 6 .141-IN-ID	28480	2190-0008
	2190-0009	4	8	WASHER-LK INTL T NO. 8 .168-IN-ID	28480	2190-0009
	2190-0124	4	1	WASHER-LK INTL T NO. 10 .195-IN-ID	28480	2190-0124
	2360-0209	7	4	SCREW-MACH 6-32 1-IN-LG PAN-HD-POZI	00000	ORDER BY DESCRIPTION
	2580-0002	4	8	NUT-HEX-DBL-CHAM 8-32-THD .085-IN-THK	28480	2580-0002
	2950-0078	9	1	NUT-HEX-DBL-CHAM 10-32-THD .067-IN-THK	28480	2950-0078
	3050-0079	3	1	WASHER-FL NM NO. 2 .094-IN-ID .188-IN-OD	28480	3050-0079
	7100-1204	9	1	CAN-RECY 2.00"	28480	7100-1204

See introduction to this section for ordering information

\*Indicates factory selected value

†Backdating information in Section VII

Table 6-2. Replaceable Parts

Reference Designation	HP Part Number	C	D	Qty	Description	Mfr Code	Mfr Part Number
A9†	00436-60054	2		1	POWER SUPPLY ASSEMBLY	28480	00436-60054
A9C1	0180-1985	4		2	CAPACITOR-FXD 500UF+75-10% 30VDC AL	28480	0180-1985
A9C2	0180-1985	4		2	CAPACITOR-FXD 500UF+75-10% 30VDC AL	28480	0180-1985
A9C3†	0180-3344	3		2	CAPACITOR-FXD 2.2UF +-20% 50VDC AL	28480	0180-3344
A9C4†	0180-3344	3		2	CAPACITOR-FXD 2.2UF +-20% 50VDC AL	28480	0180-3344
A9C5†	0180-3343	2		2	CAPACITOR-FXD 10UF+-20% 25VDC AL	28480	0180-3343
A9CR1	1901-0200	5		2	DIODE-PWR RECT 100V 1.5A	28480	1901-0200
A9CR2	1901-0200	5		2	DIODE-PWR RECT 100V 1.5A	28480	1901-0200
A9CR3	1901-0328	8		4	DIODE-PWR RECT 400V 1A 6US	03508	A14D
A9CR4	1901-0328	8		4	DIODE-PWR RECT 400V 1A 6US	03508	A14D
A9CR5	1901-0328	8		4	DIODE-PWR RECT 400V 1A 6US	03508	A14D
A9CR6	1901-0328	8		4	DIODE-PWR RECT 400V 1A 6US	03508	A14D
A9F1†				4	NOT ASSIGNED		
A9F2†					NOT ASSIGNED		
A9F3†					NOT ASSIGNED		
A9R1†	0698-3442	9		1	RESISTOR 237 1% .125W F TC=0+-100	24546	C4-1/8-T0-237R-F
A9R2†	0698-3150	6		1	RESISTOR 2.37K 1% .125W F TC=0+-100	24546	C4-1/8-T0-2371-F
A9R3†	2100-3123	0		1	RESISTOR-TRMR 500 10% C SIDE-ADJ 17-TRN	02111	43P501
A9TP1	0360-1514	7			TERMINAL-STUD SGL-PIN PRESS-MTG	28480	0360-1514
A9TP2	0360-1514	7			TERMINAL-STUD SGL-PIN PRESS-MTG	28480	0360-1514
A9TP3	0360-1514	7			TERMINAL-STUD SGL-PIN PRESS-MTG	28480	0360-1514
A9TP4	0360-1514	7			TERMINAL-STUD SGL-PIN PRESS-MTG	28480	0360-1514
A9TP5	0360-1514	7			TERMINAL-STUD SGL-PIN PRESS-MTG	28480	0360-1514
A9TP6	0360-1514	7			TERMINAL-STUD SGL-PIN PRESS-MTG	28480	0360-1514
A9U1†	1826-0277	6		1	IC V RGLTR-FXD-NEG 14.4/15.6V T0-220 PKG	27014	LM320T-15
A9U2†	1826-0393	7		1	IC V RGLTR-ADJ-POS 1.2/37V T0-220 PKG	27014	LM317T
					A9 MISCELLANEOUS PARTS		
	2200-0103	2		2	SCREW-MACH 4-40 .25-IN-LG PAN-HD-POZI	28480	2200-0103
	5000-9043	6		1	PIN:P.C. BOARD EXTRACTOR	28480	5000-9043
	5040-6845	4		1	PC BOARD EXTRACTOR, WHITE	28480	5040-6845
A10	00436-60009	7		1	MOTHER BOARD ASSEMBLY	28480	00436-60009
A10J1	1200-0508	0		1	SOCKET-IC 14-CONT DIP-SLDR	28480	1200-0508
A10J2	1200-0507	9		1	SOCKET-IC 16-CONT DIP-SLDR	28480	1200-0507
A10J3	1251-3898	4		2	CONNECTOR 10-PIN M POST TYPE	28480	1251-3898
A10J4	1251-3898	4		2	CONNECTOR 10-PIN M POST TYPE	28480	1251-3898
A10VR1	1902-0551	1		1	DIODE-ZNR 6.2V 5% PD=1W IR=10UA	28480	1902-0551
A10XU1					NOT ASSIGNED		
A10XU2	1251-1365	6			CONNECTOR-PC EDGE 22-CONT/ROW 2-ROWS	28480	1251-1365
A10XU3	1251-1365	6			CONNECTOR-PC EDGE 22-CONT/ROW 2-ROWS	28480	1251-1365
A10XU4	1251-1365	6			CONNECTOR-PC EDGE 22-CONT/ROW 2-ROWS	28480	1251-1365
A10XUSA	1251-1365	6		5	CONNECTOR-PC EDGE 22-CONT/ROW 2-ROWS	28480	1251-1365
A10XUSB	1251-1626	2		1	CONNECTOR-PC EDGE 12-CONT/ROW 2-ROWS	28480	1251-1626
A10XU6	1251-1365	6			CONNECTOR-PC EDGE 22-CONT/ROW 2-ROWS	28480	1251-1365
					A10 MISCELLANEOUS PARTS		
	2190-0007	2		4	WASHER-LK INTL T NO. 6 .141-IN-ID	28480	2190-0007
	2360-0195	0		4	SCREW-MACH 6-32 .312-IN-LG PAN-HD-POZI	28480	2360-0195
A11	0960-0444	2		1	LINE MODULE-UNFILTERED	28480	0960-0444
W3	00436-60023	5		1	CABLE ASSEMBLY-MOLEX, FRONT	28480	00436-60023
W3P1	1251-3537	8		2	CONNECTOR 10-PIN F POST TYPE	28480	1251-3537
†	1251-3966	7		19	CONTACT-CONN U/W-POST-TYPE FEM CRP	28480	1251-3966
W3P2	1251-0512	3		1	CONNECTOR 5-PIN F POST TYPE	28480	1251-0512

See introduction to this section for ordering information  
 \*Indicates factory selected value  
 †Backdating information in Section VII

Table 6-2. Replaceable Parts

Reference Designation	HP Part Number	C D	Qty	Description	Mfr Code	Mfr Part Number
W7	00436-60024	6	1	CABLE ASSEMBLY-MOLEX, REAR	28480	00436-60024
W7P1	1251-3537	8		CONNECTOR 10-PIN F POST TYPE	28480	1251-3537
†	1251-3966	7		CONTACT-CONN U/W-POST-TYPE FEM CRP	28480	1251-3966
C1	0180-2221	3	1	CAPACITOR-FXD 7200UF+75-10% 15VDC AL	28480	0180-2221
	0360-0270	0	2	TERMINAL-SLDR LUG LK-MTG FOR-#10-SCR	28480	0360-0270
	2680-0128	7	2	SCREW-MACH 10-32 .25-IN-LG PAN-HD-POZI	00000	ORDER BY DESCRIPTION
†	00436-20055	9	1	CLAMP-CAP 2.062-DIA STL	28480	00436-20055
C2	0180-0197	8	1	CAPACITOR-FXD 2.2UF+-10% 20VDC TA	56289	150D225X9020A2
C3	0160-2437	1	3	CAPACITOR-FDTHRU 5000PF +80 -20% 200V	28480	0160-2437
	2190-0009	4		WASHER-LK INTL T NO. 8 .168-IN-ID	28480	2190-0009
	2580-0002	4		NUT-HEX-DBL-CHAM 8-32-THD .085-IN-THK	28480	2580-0002
C4	0160-2437	1		CAPACITOR-FDTHRU 5000PF +80 -20% 200V	28480	0160-2437
	2190-0009	4		WASHER-LK INTL T NO. 8 .168-IN-ID	28480	2190-0009
	2580-0002	4		NUT-HEX-DBL-CHAM 8-32-THD .085-IN-THK	28480	2580-0002
C5	0160-2437	1		CAPACITOR-FDTHRU 5000PF +80 -20% 200V	28480	0160-2437
	2190-0009	4		WASHER-LK INTL T NO. 8 .168-IN-ID	28480	2190-0009
	2580-0002	4		NUT-HEX-DBL-CHAM 8-32-THD .085-IN-THK	28480	2580-0002
F1	2110-0063	2	1	FUSE .75A 250V NTD 1.25X.25 UL (FOR 100, 120 VAC OPERATION)	28480	2110-0063
F1	2110-0421	6	1	FUSE .375A 250V TD 1.25X.25 UL (FOR 220, 240 VAC OPERATION)	75915	313.375
J1				MOUNT-CONNECTOR, FRONT: PART OF W5		
J2				REFERENCE OSCILLATOR, FRONT: P/O W6		
	0590-0011	4	1	NUT-KNRLD-R 5/8-24-THD .125-IN-THK	28480	0590-0011
J3	1250-0083	1	2	CONNECTOR-RF BNC FEM SGL-HOLE-FR 50-OHM	28480	1250-0083
	2190-0016	3	2	WASHER-LK INTL T 3/8 IN .377-IN-ID	28480	2190-0016
	2950-0001	8	2	NUT-HEX-DBL-CHAM 3/8-32-THD .094-IN-THK	00000	ORDER BY DESCRIPTION
J4	1250-0083	1		CONNECTOR-RF BNC FEM SGL-HOLE-FR 50-OHM	28480	1250-0083
	2190-0016	3		WASHER-LK INTL T 3/8 IN .377-IN-ID	28480	2190-0016
	2950-0001	8		NUT-HEX-DBL-CHAM 3/8-32-THD .094-IN-THK	00000	ORDER BY DESCRIPTION
J5				REFERENCE OSCILLATOR CONNECTOR, REAR PART OF W10		
J6				MOUNT-CONNECTOR, REAR: P/O W9		
J7	1251-3283	1	1	CONNECTOR 24-PIN F MICRORIBBON (PART OF A7, OPTION 022 ONLY)	28480	1251-3283
MECHANICAL PARTS						
MP1	0520-0128	7	1	SCREW-MACH 2-56 .25-IN-LG PAN-HD-POZI	00000	ORDER BY DESCRIPTION
MP2	1460-1345	5	1	TILT STAND SST	28480	1460-1345
MP3	2190-0045	8	1	WASHER-LK HLCL NO. 2 .088-IN-ID	28480	2190-0045
MP4	2360-0115	4	14	SCREW-MACH 6-32 .312-IN-LG PAN-HD-POZI	00000	ORDER BY DESCRIPTION
MP5	2360-0334	9	4	SCREW-MACH 6-32 .312-IN-LG 100 DEG	28480	2360-0334
MP6	2510-0192	6	8	SCREW-MACH 8-32 .25-IN-LG 100 DEG	00000	ORDER BY DESCRIPTION
MP7†				NOT ASSIGNED		
MP8	6960-0027	3	1	PLUG-HOLE STD. HD .625'DIA NYLON (OMIT ON OPTION 003)	28480	6960-0027
MP9	5001-0439	8	2	TRIM, FRONT SIDE	28480	5001-0439
MP10	5020-8815	0	1	FRAME-FRONT	28480	5020-8815
MP11	5020-8879	6	2	STRUT-CORNER	28480	5020-8879
MP12	5040-7201	8	4	FOOT (STANDARD)	28480	5040-7201
MP13	5040-7203	0	1	TRIM STRIP	28480	5040-7203
MP14	5060-9971	5	1	COVER-PERFORATED, BOTTOM	28480	5060-9971
MP15	00436-00002	4	1	SUPPORT-RIGHT HAND	28480	00436-00002
MP16	00436-00003	5	1	SUPPORT-LEFT HAND	28480	00436-00003
MP17	00436-00011	5	1	COVER-PLATE, BLANK	28480	00436-00011
MP18	00436-00018	2	1	COVER-TOP, UPPER PERFORATED	28480	00436-00018
MP19	5020-8816	1	1	FRAME-REAR	28480	5020-8816
MP20	00436-00007	9	1	PANEL-REAR	28480	00436-00007
MP21	00436-00008	0	1	SHIELD-POWER SUPPLY	28480	00436-00008
MP22	00436-00013	7	1	COVER-TRANSFORMER	28480	00436-00013
MP23	00436-00001	3	1	SUB-PANEL, FRONT	28480	00436-00001
MP24	00436-00004	6	1	PANEL-FRONT, LOWER	28480	00436-00004
	0370-0914	0	1	BEZEL-PB KNOB, .490LG, .330W, .165HI, JADE	28480	0370-0914

See introduction to this section for ordering information  
 \*Indicates factory selected value  
 †Backdating information in Section VII

Table 6-2. Replaceable Parts

Reference Designation	HP Part Number	C D	Qty	Description	Mfr Code	Mfr Part Number
MP25	00436-20017	3	1	WINDOW-FRONT	28480	00436-20017
MP26	5040-6927	3	1	STRIP	28480	5040-6927
MP27†	00436-00029	5	1	SCREEN, RFI	28480	00436-00029
MP28	2190-0018	5	1	WASHER-LK HLCL NO. 6 .141-IN-ID	28480	2190-0018
P1	0362-0192	9	10	CONNECTOR-SGL CONT QDISC-FEM	28480	0362-0192
P2	0362-0192	9		CONNECTOR-SGL CONT QDISC-FEM	28480	0362-0192
P3	0362-0192	9		CONNECTOR-SGL CONT QDISC-FEM	28480	0362-0192
P4	0362-0192	9		CONNECTOR-SGL CONT QDISC-FEM	28480	0362-0192
P5	0362-0192	9		CONNECTOR-SGL CONT QDISC-FEM	28480	0362-0192

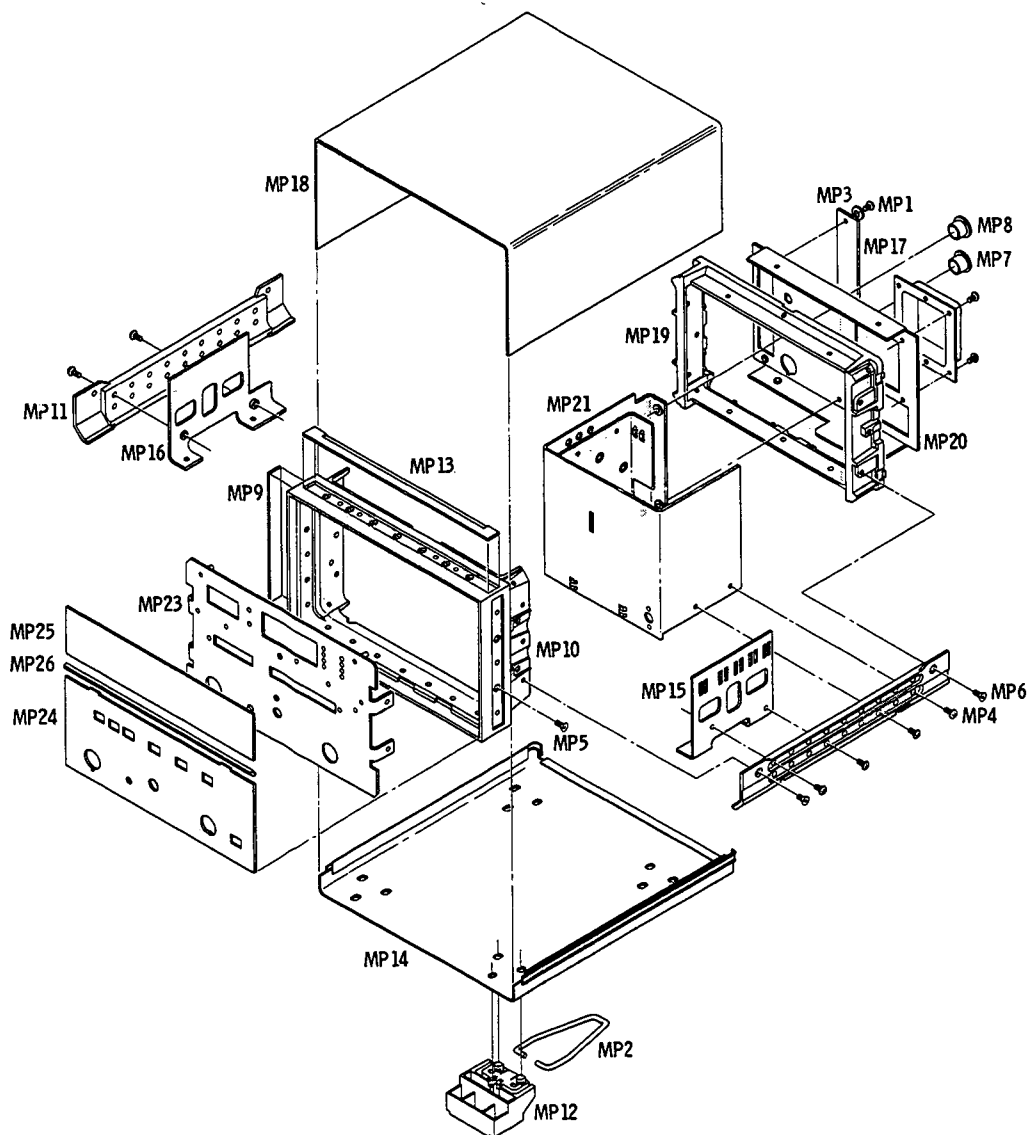

Figure 6-1. Cabinet Parts

See introduction to this section for ordering information  
 \*Indicates factory selected value  
 †Backdating information in Section VII

Table 6-2. Replaceable Parts

Reference Designation	HP Part Number	C D	Qty	Description	Mfr Code	Mfr Part Number
P6	0362-0192		9	CONNECTOR-SGL CONT QDISC-FEM	28480	0362-0192
P7	0362-0192		9	CONNECTOR-SGL CONT QDISC-FEM	28480	0362-0192
P8	0362-0192		9	CONNECTOR-SGL CONT QDISC-FEM	28480	0362-0192
P9	0362-0192		9	CONNECTOR-SGL CONT QDISC-FEM	28480	0362-0192
P10	0362-0192		9	CONNECTOR-SGL CONT QDISC-FEM	28480	0362-0192
S1	00436-60028	0	1	POWER SWITCH ASSEMBLY	28480	00436-60028
	00436-60014	4	1	POWER SWITCH CONNECTOR ROD	28480	00436-60014
	0510-0067	2	2	NUT-SHMET-U-TP 4-40-THD .21-WD STL	28480	0510-0067
	2200-0105	4	2	SCREW-MACH 4-40 .312-IN-LG PAN-HD-POZI	00000	ORDER BY DESCRIPTION
S106†	0160-4065	5	1	CAPACITOR-FXD .1UF +-20% 250VAC(RMS)	28480	0160-4065
T1	9100-0647	4	1	TRANSFORMER-POWER 100/120/220/240V	28480	9100-0647
	2360-0139	2	4	SCREW-MACH 6-32 2-IN-LG PAN-HD-POZI	00000	ORDER BY DESCRIPTION
	0590-0025	0	4	NUT-HEX-PLSTC LKG 6-32-THD .172-IN-THK	28480	0590-0025
TB1	5020-8122	2	1	LINE VOLTAGE SELECTOR CARD	28480	5020-8122
U1	1826-0181	1	1	IC V RGLTR TO-3	27014	LM323K
	0626-0002	0	2	SCREW-TPG 6-20 .5-IN-LG PAN-HD-SLT	00000	ORDER BY DESCRIPTION
W1	8120-0619	1	1	CABLE ASSEMBLY	28480	8120-0619
W2	8120-0617	9	1	CABLE ASSY 26AWG 16-CNDCT	28480	8120-0617
W3				SEE INFORMATION FOLLOWING A11		
W4	8120-1733	2	1	CABLE ASSY 26AWG 16-CNDCT (NOT USED ON OPTION 022)	28480	8120-1733
W5†	00436-60032	6	2	CABLE ASSEMBLY-SENSOR INPUT (INCL J1)	28480	00436-60032
	00436-20014	0	2	WASHER-CONNECTOR MOUNT	28480	00436-20014
	1251-3362	7	2	NUT-AUDIO CONN	28480	1251-3362
W6	00436-60029	1	1	CABLE-REFERENCE OSCILLATOR OUTPUT (INCL J2)	28480	00436-60029
W7				SEE INFORMATION FOLLOWING A11		
W8	8120-1378	1	1	CABLE ASSY 18AWG 3-CNDCT JGK-JKT	28480	8120-1378
W9	00436-60032	6	1	CABLE-SENSOR IN REAR (INCL J6: OPTION 002 AND 003)	28480	00436-60032
	00436-20014	0	1	WASHER-CONNECTOR MOUNT	28480	00436-20014
	1251-3362	7	1	NUT-AUDIO CONN	28480	1251-3362
W10	00436-60033	7	1	CABLE-REFERENCE OSCILLATOR REAR (INCL J OPTION 003 ONLY)	28480	00436-60033
W11	8120-3304	7	1	CABLE-DATA (OPT. 022)	28480	8120-3304
W12	11730A	4	1	CABLE ASSEMBLY-5'	28480	11730A
W12	11730B	6	1	CABLE ASSY-SENSOR 10'	28480	11730B
W12	11730C	8	1	CABLE ASSY-SENSOR 20'	28480	11730C
W12	11730D	0	1	CABLE ASSY-SENSOR 50'	28480	11730D
W12	11730E	2	1	CABLE ASSY-SENSOR 100'	28480	11730E
W12	11730F	4	1	CABLE ASSY-SENSOR 200'	28480	11730F
XA1-XA9	1251-2309	0	1	NOT ASSIGNED CONNECTOR-PC EDGE 12-CONT/ROW 1-ROW	28480	1251-2309

See introduction to this section for ordering information

\*Indicates factory selected value

†Backdating information in Section VII

Table 6-3. Code List of Manufacturers

Mfr Code	Manufacturer Name	Address	Zip Code
00000	ANY SATISFACTORY SUPPLIER		
01121	ALLEN-BRADLEY CO	MILWAUKEE WI	53204
01295	TEXAS INSTR INC SEMICOND CMPNT DIV	DALLAS TX	75222
02111	SPECTROL ELECTRONICS CORP	CITY OF IND CA	91745
03508	GE CO SEMICONDUCTOR PROD DEPT	AUBURN NY	13201
04713	MOTOROLA SEMICONDUCTOR PRODUCTS	PHOENIX AZ	85008
06665	PRECISION MONOLITHICS INC	SANTA CLARA CA	95050
07263	FAIRCHILD SEMICONDUCTOR DIV	MOUNTAIN VIEW CA	94042
19701	MEPCO/ELECTRA CORP	MINERAL WELLS TX	76067
20940	MICRO-OHM CORP	EL MONTE CA	91731
24046	TRANSITRON ELECTRONIC CORP	WAKEFIELD MA	01880
24546	CORNING GLASS WORKS (BRADFORD)	BRADFORD PA	16701
27014	NATIONAL SEMICONDUCTOR CORP	SANTA CLARA CA	95051
28480	HEWLETT-PACKARD CO CORPORATE HQ	PALO ALTO CA	94304
3L585	RCA CORP SOLID STATE DIV	SOMERVILLE NJ	
30983	MEPCO/ELECTRA CORP	SAN DIEGO CA	92121
32997	BOURNS INC TRIMPOT PROD DIV	RIVERSIDE CA	92507
56289	SPRAGUE ELECTRIC CO	NORTH ADAMS MA	01247
75915	LITTELFUSE INC	DES PLAINES IL	60016
91637	DALE ELECTRONICS INC	COLUMBUS NE	68601